



2019 Parts Catalog



Buick Riviera

BUICK PARTS: GROUP NUMBERS

Engine • Clutch • Decals.....	Group 0
Cooling • Oiling • Grills	Group 1
Electrical • Lamps	Group 2
Fuel • Carburetion • Exhaust.....	Group 3
Transmission • Brakes	Group 4
Wheels • Propeller Shaft • Rear Axle	Group 5
Front Suspension • Steering	Group 6
Frame • Springs • Shocks • Bumpers	Group 7
Hood • Front Fenders • Running Boards.....	Group 8
Heater • Air Conditioner • Firewall • Radio • Antenna	Group 9
Glass • Doors • Cowl • Weatherstrip • Wiper • Dash.....	Group 10
Rear 1/4 Glass • Seats • Door Sills • Dome Lenses	Group 11
Rocker Panels • Rear Sheet Metal • Deck Lid.....	Group 12
Convertible Tops and Parts	Group 13
Door Panels • Misc. Interior • Headlinings	Group 14
Carpet • Floor Mats • Trunk Linings	Group 15
Literature.....	Group 16

-ATTENTION-

This catalog pertains to
1963 and Up Riviera ONLY

We also have catalogues and stock Buick parts for:

1930's and Up All models

1961 and Up Special, Skylark, Sportwagon and Gran Sport

1961 and Up LeSabre, Invicta, Wildcat,
Electra 225, Centurion, Century and Apollo

1973 and Up Regal, Grand National, T-Type and GNX

Please inquire about separate catalogs for the above Buicks

www.oldbuickparts.com

All rights reserved. No part of this publication may be reproduced without prior written permission from CARS, Inc. Illustrations in this catalog are representations only and may not exactly depict any particular part or part number. Prices subject to change without notice.

Typical 1963-1975 Buick V-8 Engine

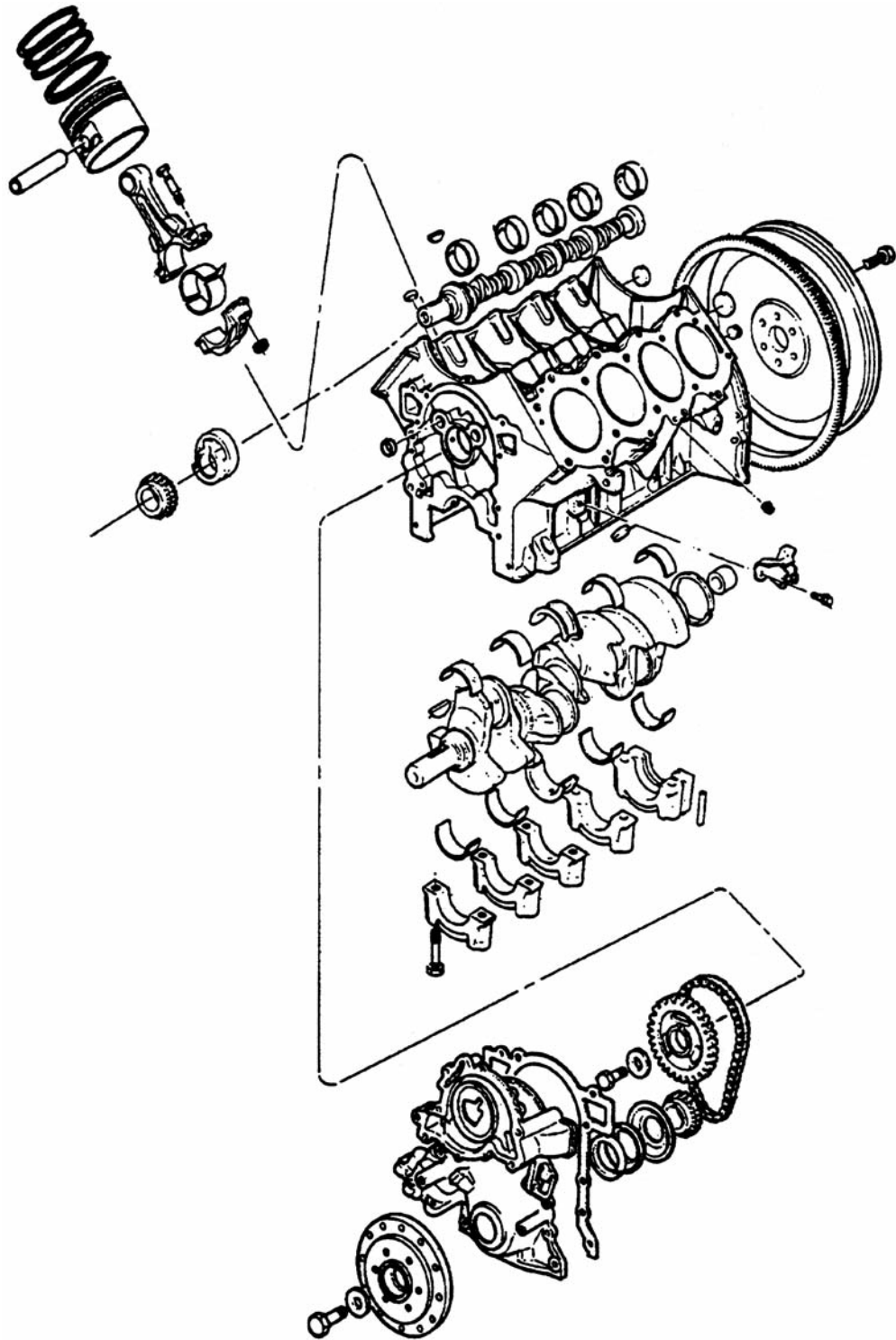

Engine Parts (Group 0)

Motor Mounts (.027)



1963-1965 All except 65 GS front motor mounts.
MM615.....\$58.00 pr.

1967-1976 All with four hole flange. Left and right sides.
MM676.....\$52.00 pr.

Motor Mount Rebuilding Service

We can only rebuild mounts listed below.
Please inquire.

1965-1966

1965: GS;

1966: Front motor mounts.

MM656R.....\$182.75 pr.

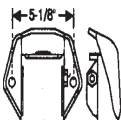

1967-1970 Riviera first type, #'s 1231008-9

There are two types. This is not the interlocking type.

MM670.....\$191.69 pr.

Crankshaft Main Bearing Sets

1963-1966 Riviera 401-425 Main bearing set.
MBS596.....\$179.50 set

1967-1969 All 430 engines. Main bearing set.
MBS679.....\$97.50 set

1970-1976 All 455 engines. Main bearing set.
MBS706.....\$129.00 set

Connecting Rods



1963-1965 401 and 425 engines.
CR596.....\$49.25 ea.

1967-1972 430 and 455 engines.
CR672.....\$59.25 ea.

Connecting Rods Bearings

1963-1976
RBS576.....\$89.50 set



Timing Chain Covers

1963-1966 All.
TC576.....\$379.50 ea.

1967-1976 All 400, 430 and 455 engine. A top quality item manufactured from 356-T6 aluminum with improvements such as upgraded coolant and oil passages. Includes neoprene front seal.

TC676.....\$479.00 ea.



Timing Cover Seals

Our modern steel housed, silicon seals replace the OEM "rope" seal and steel retainer. A spring insert keeps pressure against balancer for improved sealing.



1963-1966 All
TCS536L.....\$12.75 ea.

1967-1976 All
TCS650.....\$17.00 ea.

Timing Chain Sets

1963-1966 All. Timing chain set with iron cam gear.

TS576.....\$108.50 set

TC536.....Chain Only.....\$34.50 ea.



1967 Early 430 engines.
TS67E.....\$68.75 set

1967-1976 Timing chain set.

1967: Late 430 engines;

1968-1976: All.

TS676.....\$56.25 ea.

Timing Cover Gasket Sets

Sets Contain Standard Rope Seal



1963-1966 All.
TCS536.....\$27.25 set

1967-1976 All.
TCS676.....\$25.25 set

ZDDP Oil Supplement - 4 oz. Bottle



ZDDPlus is a oil additive that contains high concentrations of Zinc Diakyl Dithiophosphate, which has been the primary extreme pressure ingredient now missing from modern day motor oils. This is a must in all flat-tappet engines!
ZDDP\$14.00 ea.

ZDDP5.....(5 Bottles).....\$39.95



Camshafts



- 1963-1966 All.**
CS576\$169.50 ea.
- 1967-1976 430 and 455 engines, except stage one.**
CS676\$179.50 ea.
- 1982-1983 Riviera w/ V-6; 1984-1985 All with V-6 Turbo.**
CS785\$95.50 ea.
- All Years. All Engines. Cam break-in lube.**
CL300.....\$7.50 ea.

Camshaft Bearings Sets

- 1963-1966 All.**
CBS576\$47.50 set
- 1967-1976 All.**
CBS676\$54.00 set

Pistons

- 1961-1966 All 400, 401 engines. Piston and pin.**
P401S.....(Set of 8).....\$287.00 set
- 1963-1966 All 425 engines. Piston and pin.**
P425\$54.50 ea.
P425S.....(Set of 8).....\$325.00 set
- 1967-1969 430 engines.**
P679S.....(Set of 8).....\$535.00 set
- 1970-1976 All 455 engines. Piston and pin.**
P706\$57.25 ea.
P706S.....(Set of 8).....\$530.00 set

Piston Ring Sets

- 1963-1966 401 engines.**
PRS401C.....(cast iron).....\$94.50 set
PRS401M.....(moly)\$139.00 set
- 1963-1966 425 engine. Cast iron.**
PRS425C.....\$78.25 set
- 1967-1969 430 engine. Cast iron.**
PRS430C.....\$187.50 set
- 1970-1976 455 engine.**
PRS455C.....(cast iron).....\$64.50 set
PRS455M.....(moly)\$95.00 set
- 1977-1981 350 engine.**
PRS350M.....(moly)\$64.50 set

Harmonic Balancers



- 1967-1976 all 400, 430, 455 engines.**
Sold outright.
HB676\$285.00 ea.

Harmonic Balancer Rebuilding Service (.659)



Balancers are completely disassembled shot peened and inspected. Threaded holes are repaired and new seal saver is installed.(non-rope seal apps.) New silicone rubber is injected, then vulcanized for proper bonding. Please remove any bolted pulleys before sending. For those not listed, please inquire.

- 1959-1966 All 400, 401 engines. Riveted type.**
HB401RS\$199.50 ea.
- 1963-1966 All 425 engines. Riveted hub seal dia. 2.00 inches, 1.440 id.**
HB425RS\$249.00 ea.
- 1977-1981 All 350 engines. .750 wide ring externally balanced hub and ring.**
HB350RS\$108.00 ea.
- 1967-1976 430,455 engine. 1.100 wide ring. Externally balanced.**
HB455RS\$199.50 ea.

Harmonic Balancer Bolt

- 1967-1976 All 400, 430, 455 engines.**
HBB676\$7.50 ea.

Harmonic Balancer Washer

- 1967-1976 All 400, 430, 455 engines.**



www.oldbuickparts.com
908-369-3666

Engine Parts (Group 0)



Valves-Intake

1963-1966 All.	
IV596.....	\$14.25 ea.
1967-1976 430 and 455. Except GS.	
IV676.....	\$11.50 ea.
1968-1980 350 engine.	
IV680.....	\$10.00 ea.
1971-1974 455 Stage 1.	
IV714.....	\$17.00 ea.

1971-1974 Riviera GS.	
IV714GS.....	\$15.50 ea.

Valves - Exhaust

1963-1966 All.	
EV596.....	\$16.50 ea.
1967-1974 430 and 455 engines. Except GS.	
EV674.....	\$14.75 ea.
1975-1976 455 engines.	
EV756.....	\$18.50 ea.

Valve Guides



1963-1965 401 and 425 engines. (int./ext.).	
VV733.....	\$4.00 ea.
1966 All with 401 engine. Valve guide. (intake).	
VG937.....	\$3.00 ea.
1966 All with 425 engine. Valve guide. (intake).	
VG733.....	\$4.00 ea.
1967-1976 All. Valve guide. (intake).	
VG6113.....	\$2.75 ea.
1967-1976 All. Valve guide. (exhaust).	
VG6114.....	\$2.75 ea.

Freeze Plug Kits

Kits contain necessary plugs for block, cam, oil holes.
"B" kits contain brass plugs for water jackets.

1963-1966 All.	
FPK536.....	\$18.50 each kit
1967-1976 All 430 and 455 engines. Steel.	
FPK670.....	\$10.00 ea.
1967-1976 All 430 and 455 engines. Brass.	
FPK670B.....	\$15.50 ea.
1977-1980 All 350 engines. Steel.	
FPK640.....	\$10.50 ea.
1977-1980 All 350 engines. Brass.	
FPK640B.....	\$10.00 ea.

Flywheels

1967-1976 All. 430, 455 engines with auto transmission.	
FW676.....	\$99.00 ea.



Valve Spring Retainers (.310) (Keepers)

1963-1975 all V-8 engines.	
32 pairs needed per car.	
VR365.....	\$3.75 pr.
VR365S.....	Set of 32.....\$49.50 set



Valve Springs

1963-1966 All. (inner).	
VS536.....	\$5.00 ea.
VS536S.....	Set of 16.....\$58.00 set
1963-1966 All. (outer).	
VS596.....	\$4.75 ea.
1963-1966 All. Complete set of 16 valve springs.	
VS596S.....	\$52.25 set
1967-1972 All except GS. Intake and exhaust.	
VS672.....	\$4.50 ea.
VS672S.....	Set of 16.....\$58.00 set
1971-1974 Riviera GS. Intake and exhaust.	
VS714.....	\$4.75 ea.
1973-1974 All. Intake and exhaust.	
VS734.....	\$4.75 ea.

Valve Seat Inserts

1963-1966 All. (intake).	
VSI592.....	\$4.75 ea.
1963-1966 All. (exhaust).	
VSI590.....	\$4.75 ea.
1967-1969 430 engines. (exhaust).	
VSI648.....	\$8.00 ea.
1967-1974 All except Riviera GS. (intake).	
VSI674.....	\$8.00 ea.
1970-1974 All except Riviera. (exhaust).	
VSI704.....	\$5.00 ea.

Valve Stem Seals

1963-1966 All.	
VSS536.....	\$3.00 ea.
1967-1974 350, 430 and 455 engines.	
VSS674.....	\$2.75 ea.



Rear Main Seal

1963-1966 All. Modern lip seal replaces OEM "rope" seal.	
RMS576.....	\$24.50 ea
1967-1976 All. Replaces OEM "rope" seal. Metal encased lip seal.	
RMS650.....	\$25.25 ea.



Rocker Arm Assemblies (Sold Outright)

- 1968-1981** 350 engine.
RAA680\$265.00 pr.
- 1970-1971** 455 engine.
RAA702\$179.50 pr.

Rocker Arm Assembly Rebuilding

- 1961-1966** All 364, 401, 425 engines.
RAA596\$379.50 pr.
- 1967-1976** All 400, 430, 455 engines.
RAA676\$399.00 pr.

Rocker Arm Shafts

- 1963-1966** 401 and 425 engines. Either side.
RS536.....\$48.50 ea.
RS536P.....Pair.....\$95.00 pr.
- 1967-1969** 430 engines. Either side.
RS689.....\$55.00 ea.
- 1977-1976** 455 engine. Either side.
RS705.....\$55.00 ea.
- 1977-1981**
RS700.....\$39.50 ea.



www.oldbuickparts.com
908-369-3666

Rocker Arms and Sets

- 1963-1966** All 401, 425 engines. Reproduced in steel. Set includes 16 rocker arms.
RAS536\$225.00 set

- 1963-1966** All 364, 400, 401, 425 engines.
Fits LH 4 Rear and RH 4 Front.
Reproduced in steel.
RA596A.....\$17.00 ea.



- 1963-1966** All 364, 400, 401, 425 engines.
Fits RH 4 Rear and LH 4 Front.
Reproduced in steel.
RA596B.....\$17.00 ea.



- 1968-1969** 350, 400, 430 Engines.
Intake #1, 4, 5, 8. Exhaust #2, 3, 6, 7.
RA689A\$17.00 ea.



- 1968-1969** 350, 400, 430 Engines.
Intake #2, 3, 6, 7. Exhaust #1, 4, 5, 8.
RA689B\$17.00 ea.

- 1968-1969** 350, 400, 430 Engines.
Complete rocker arm set.
RA689S\$259.00 set

- 1970-1975** 455 Engine. Intake #1,4,5,8. Exhaust #2,3,6,7.
RA705A\$8.50 ea.

- 1970-1975** 455 Engine. Intake #2,3,6,7. Exhaust #1,4,5,8.
RA705B\$8.50 ea.

- 1970-1975** 455 Engine. Complete rocker arm set.
RA705S\$105.25 set

Rocker Arm Retainers

- 1970-1972** All. Rocker arm retainers.
For use with aluminum rocker arms.
16 per car. Nylon.
RR702\$1.75 ea.





Oil Slinger

- 1977-1981** All 350 engines.
OS615\$11.75 ea.

Engine Parts (Group 0)

Valve Rocker Cover Parts

 **1963-1966** Valve rocker cover bolt grommet.
Four per car.
VCG572\$3.75 ea.

 **1963-1966** Valve cover vent, rubber grommet.
(1" hole).
VG634\$7.75 ea.

 **1964-1967** Solid rocker cover plug.
CP647\$13.50 ea.

 **1967-1974** Intake manifold vent grommet.
VG634\$7.75 ea.

 **1970-1974** All V-8, left hand valve cover grommet.
..VG704.....\$6.00 ea.

1964-1967

1964-1966: GS with 2-4 carbs;

1967: with engine dress up kit.

"AC OIL" Chrome twist on cap.

OC647.....(chrome).....\$39.50 ea.

OC397.....(black).....\$34.50 ea.

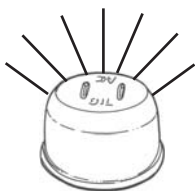

Breather Tubes (1.762)

(Air Cleaner to Rocker Cover)

 **1968-1969** All 350, 400, 430 engine
except 1968 2bbl.
VT689\$19.50 ea.

 **1970-1971** all V-8; **1972** all 455
engines.
VT704\$19.50 ea.

Crankcase Vent Hose (To Carb) (1.726)

1967 400, 430:

1968-1971 All 4BBL engines.

VH671.....\$28.00 ea.

1971-1975 All 350 and 455 engines with 4BBL
carb. (Formed hose).

VH725.....\$24.50 ea.



Chrome Valve Cover Set



1970-1976 Buick 455 Engines

1967-1969 Buick 455 Engines -(Will Fit
But Look Different)

A beautiful chrome valve cover set.

VC555C.....\$149.50 pr.

Aluminum Valve Covers

1963-1966 all 401, 425 engines.
Grooved with "BUICK" as original.
Nice reproduction!
AVC536.....\$239.00 pr.



1953-1966 all with aluminum valve covers.
Spark plug wire retainer stanchion.

Chrome plated.

WRS636.....\$37.50 pr.

Powder coated so not to flake, peel or chip. Tall valve covers
allow use of adjustable roller rockers, large valves, springs
and retainers. Thick aluminum construction allows for even
gasket compression and proper sealing. Will not bend, dent
or distort. Results in reduced engine noise and heat.



AVC350.....(350 Engines)\$179.50pr.

AVC455..(1967-1976 400, 430, 455 Engines)...\$179.50 pr.



1967-1976 Valve cover retaining nut and
plate.

RCS686.....\$4.25 ea.



1967-1976 Valve cover retaining nut and
plate. Chrome plated.

RCS686C\$7.50 ea.



1967-1976 Valve cover retainer with
tall stud.

RCS686T.....\$6.50 ea.



1967-1976 Valve cover retainer with
tall stud. Chrome plated.

RCS686TC.....\$8.50 ea.

Full Engine Overhaul Gasket Sets

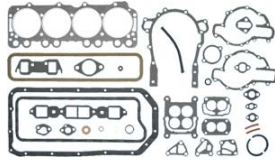

1963-1966 All.
FGS576\$139.50 set

1967-1976 430 and 455 engines. *
FGS676\$89.50 set

** Intake manifold gasket not included, please see Group 3*

Cylinder Head Gasket Sets

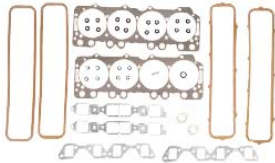

1963-1966 All.
HGS576\$112.00 set

1967-1976 430 and 455 engines. *
HGS676\$51.00 set

** Intake manifold gasket not included, please see Group 1.*

Cylinder Head Gaskets



1963-1966 All.
HG576\$77.50 pr.

1967-1976 430 and 455 engines.
HG676\$40.75 pr.

Valve Cover Gaskets



1963-1966 All.
VCG536.....\$16.50 pr.

1967-1976 All.
VCG676.....\$17.75 pr.

Push Rod Cover Gaskets



1963-1966 All.
PRG576.....\$11.50 ea.

Timing Cover Gasket Sets

Sets Contain Standard Rope Seal



1963-1966 All.
TCS536.....\$20.00 set

1967-1976 All.
TCS676.....\$25.25 set

Push Rods

1963-1966 All.
PR597\$5.75 ea.
PR597S.....(complete set of 16).....\$78.00 set

1967-1969 All.
PR669.....\$3.75 ea.
PR669S.....(complete set of 16).....\$58.00 set

1970-1976 All.
PR706.....\$4.25 ea.
PR706S..... (complete set of 16).....\$58.00 set

1977-1981 All 350 Engines.
PR701.....\$4.25 ea.
PR701S.....(complete set of 16).....\$58.00 set

Hydraulic Valve Lifters



1963-1966 All.
VL567\$9.50 ea.
VL567S.....(set of 16).....\$139.50 set

1967-1969 400-430 engines.
VL679\$7.00 ea.
VL679S.....(set of 16).....\$102.50 set

1970-1981 All 350 and 455 engines.
VL680\$4.75ea.
VL680S.....(set of 16).....\$69.50 set

Buick Engine Enamel (Group 0)

Exact Original Colors to Authenticate your Engine. Our Enamels are the Finest available. Very High Temperature. Can be easily Brushed or Sprayed to Obtain a Rich Deep Gloss. Sold in Quart or Spray Cans.

*** Note: Spray cans can not be shipped by Air.**

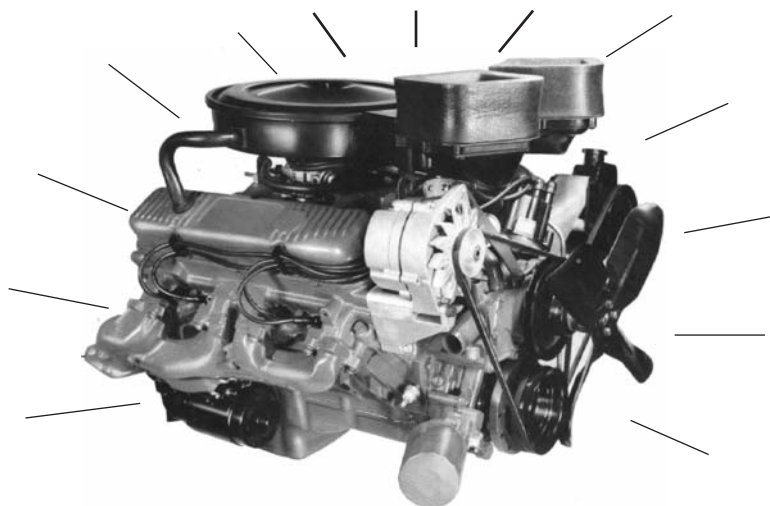

High Heat - High Gloss



Quart Cans



12 oz.
Spray Can

1963-1964	Buick Silver	EP614.....\$27.50 qt.	EP614S.....\$14.00 spray can
1963-1967	Buick Green	EP536.....\$27.50 qt.	EP536S.....\$14.00 spray can
1965-1976	Buick Red	EP644.....\$27.50 qt.	EP644S.....\$14.00 spray can

Cast Iron Paint

Extremely High Temperature - 1800 degrees. Excellent for manifolds and exhaust systems. **Will not burn OFF.**

EP3.....(pint).....\$32.00 ea.
EP3S.....(spray can).....\$19.50 ea.



Engine Compartment and Chassis Paint

Our Satin Black Enamel contains the correct blend of dulling agents to give that "Authentic New Look". Use it on inner fender wells, under hood, radiator supports brackets, fan, air cleaner, etc. It is also correct for chassis.

Spray Gun for Engine Enamels

Self-propelled unit enables you to spray up to 16 oz. of paint. Great for use on engine enamels listed above that are not available in spray cans.

SG220\$8.25 ea.
Refill cartridge.
SGR220\$6.50 ea.



All Years and Models

EP2.....(quart).....\$24.50 ea.
EP2S.....(spray can).....\$14.00 ea.

1963-1966 Air Cleaner I.D. Plates

Not just a "decal" but a high quality silk screened impression on a die cut reflective aluminum disc. Add the final touch to your highly detailed engine compartment. Will not fade or wrinkle. Easy to apply. Absolutely Show Quality. Approved and Licensed by Buick.

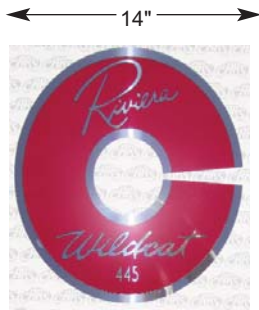

1963 401 engine "Riviera Wildcat 445".
D115A.....\$37.50 ea.

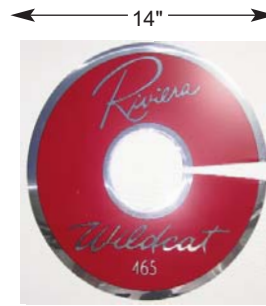

1963 425 engine "Riviera Wildcat 465".
D116A.....\$37.50 ea.

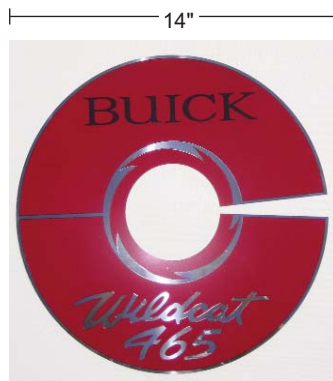

1964 All; **1966** Riviera GS "Buick Wildcat 465". 425 Engines.
D94A.....\$37.50 ea.



1965-1966 401 engines. 10" diameter
"Buick Wildcat 445".
D92A.....\$37.50 ea.



1965-1966 425 engines except GS.
"Buick Wildcat 465". 10" diameter.
D99A.....\$37.50 ea.

Riviera Decals (Group 0)

Air Cleaner Decals

D115	1963 "Riviera Wildcat 445" for engines 401..	\$15.25
D116	1963 "Riviera Wildcat 465" for engines 425..	\$15.25
D161	1963 Riviera air cleaner snorkel Wildcat head.	\$8.50
D45	1963 401 Engine A96C Air Filter Instruction...	\$5.50
D96	1965 401 Eng. Air cleaner instruct. #6420861.	\$6.25
D90	1964-1966 401 and 425 eng. Side of air cleaner decal (AC-A85C).....	\$5.50
D94	1964 All & 1966 425 engine "Buick Wildcat 465". Red 14" diameter.....	\$12.50
D56	1968-1976 "Keep your GM car all GM". #6424826.....	\$9.00
D126	1964-1966 "Super Wildcat", for 2X4-BBL cars.	\$8.00
D99	1965-1966 all 425 engines except GS. "Buick Wildcat 465" 10".....diameter.....	\$12.50
D92	1965-1966 401 engine "Buick Wildcat 445". Red 10" diameter.....	\$12.50
D98	1967 "Buick Wildcat Power". Decal.....	\$8.25
D181	1967 Air cleaner, front.....	\$7.50
D57	1967-1969 "430-4" Red & white crescent.....	\$9.00
D54	1970-1975 "455-4" Red & white crescent.....	\$9.00
D51	1970-1975 "GS-455" Red & white crescent.....	\$9.00
D51E	1970-1975 "GS-455" Red & white crescent.....	\$8.50
D52	1970-1974 "Stage 1" Red & white crescent.....	\$9.00
D314	1974-1976 "455-2V".....	\$9.00

Valve Cover Decals

D65	1967-1969 "Buick 430-4" Black and Silver.....	\$8.00
-----	---	--------

NEW Car Window Sticker and Booklet

D127	1963-1964 NEW Car Window Sticker.....	\$8.50
D371	1964 NEW Car Price Booklet.....	\$8.00
D372	1965 NEW Car Price Booklet.....	\$8.25
D129	1965-1966 NEW Car Window Sticker.....	\$8.50
D373	1966 NEW Car Price Booklet.....	\$8.25
D131	1967 NEW Car Window Sticker.....	\$8.00
D344	1968 NEW Car Window Sticker.....	\$8.50
D374	1971 NEW Car Price Booklet.....	\$8.25
D140	1971-1974 NEW Car Window Sticker.....	\$5.50



D 108



D 112



D 117



D 111



D 310



D 118

Engine Compartment Decals



D-46

D375	1961-1965 Electric Antenna Tag.....	\$8.00
D205	1961-1966 "GM" Antifreeze Tag.....	\$8.00
D171	1963 Riviera cooling system (on fan shroud)....	\$8.00
D130	1963-1964 Battery warning decal.....	\$8.00
D46	1963-1968 "Optikleen". Washer bottle label.....	\$3.75
D107	1963-1968 "Optikleen". Bottle cap decal.....	\$8.00
D80	1964 Cooling system sticker (on fan shroud)....	\$8.50
D100	1963-1975 "GM antifreeze" sticker.....	\$7.50
D125	1965-1966 Battery Warning Decal.....	\$8.25
D357	1966-1967 "Canada" oil change decal.....	\$8.50
D358	1968-1969 "Canada" oil change#734791.....	\$8.50
D179	1968-1969 "Riviera" Radiator Cap decal.....	\$7.50
D63	1968-1974 "Positive to pos." Battery sticker.....	\$4.25
D122	1965-1966 Cooling system decal (downflow)....	\$8.00
D246	1965-1966 Cross flow radiator decal.....	\$8.50
D77	1969-1975 Windshield washer bottle decal.....	\$8.00
D359	1970-1971 "Canada" oil change #733639.....	\$8.50
D210	1970-1972 Cooling system decal.....	\$8.25
D228	1980-1983 Glow plug caution 563050.....	\$8.50

Trunk Stickers

D121	1963 Riviera Jack instructions.....	\$8.00
D348	1963-1964 Jack Base Decal.....	\$8.00
D213	1964 Riviera Jack Instructions.....	\$8.50
D160	1965 Riviera Jack Instruc. trunk lid sticker.....	\$8.50
D214	1965 Riviera GS Jack instructions.....	\$8.00
D142	1966-1967 Jack Instructions.....	\$8.00
D345	1969 Riviera Jack Instructions.....	\$8.25
D346	1970 Riviera Jack Instructions.....	\$8.25
D395	1970-1972 Spare Tire inflation decal.....	\$8.50
D412	1971 Riviera Jack Instructions.....	\$8.00
D396	1971-1973 Canada Limited Slip decal.....	\$8.50
D150	1972 Jack Instructions.....	\$8.00
D216	1973 Tire stowage with regular wheel.....	\$8.00
D347	1973 Riviera Jack Instructions.....	\$8.25
D153	1973 Tire stowage with specialty wheel.....	\$8.25
D154	1974 Jack Instructions.....	\$8.00
D155	1974 Tire stowage with regular wheel.....	\$8.00
D306	1975-1976 Tire stowage with regular wheel.....	\$8.00

Garage Wall, Tool Box Decals

D108	Old Style Buick Logo (blue and white).....	\$8.50
D111	"Genuine Buick Parts" 2" x 2 1/2" Water Transfer...	\$1.50
D112	"Buick 8" 2" x 2 1/2" Water Transfer.....	\$1.50
D117	"Authorized Service" (10" diameter red, white and blue decal).....	\$8.50
D118	"Authorized Service" (5" diameter red, white and blue decal).....	\$6.50
D310	Tri-Shield 12" (red, white and blue).....	\$9.75

Interior Decals and Stickers

D386	1961-1964 Delco Battery Certificate	\$7.50
D375	1961-1965 Electric Antenna Tag	\$8.00
D71	1963-1965 Casco automatic lighter tag.	\$7.50
D279	1965-1968 Delco Battery Certificate	\$7.75
D384	1965-1968 Litter Box decal	\$8.25
D362	1966 Glove Box Tire Pres. (exc. Wildcat GS)....	\$8.50
D95E	1966-67 Embossed "GM mark of excellence".....	\$10.00
D369	1966-1969 NEW Car Factory Build Sheet	\$8.50
D376	1967 Climate Control Tag	\$8.50
D91	1967 Glove Box Tire Pressure.	\$8.50
D382	1968 "Fasten Seat Belts" decal	\$8.00
D259	1968-1969 Headlight Instruction Decal.....	\$8.25
D377	1968-1970 Climate Control Tag.....	\$8.50
D381	1968-1970 Luggage Instruction Tag	\$8.50
D55	1968-1976 "GM mark of excellence" sticker.....	\$7.50
D55E	1968-76 Embossed "GM mark of excellence".....	\$10.00
D383	1969 Lighter Instruction decal.....	\$8.25
D340	1969 Tire Pressure Decal	\$8.50
D388	1969-1972 Ignition Lock/Start Sleeve 6".....	\$8.50
D389	1969-1972 Ignition Lock/Start Sleeve 7".....	\$8.50
D105	1971 Tire Pressure Decal.	\$8.50
D380	1971-1973 Starting Instruction Tag.....	\$8.00
D378	1972-1973 A.C. Instruction Tag	\$9.25
D137	1972 Tire Pressure Decal.	\$8.50
D139	1973 Tire Pressure Decal.	\$8.50
D390	1973 Unleaded Fuel Sun Visor Sleeve	\$8.00
D342	1973-1974 Glove Box Fuel recommend	\$8.25
D391	1973-1974 Ignition Lock Instruction Sleeve....	\$8.50
D393	1974-1976 Instruction Sun Visor Start Sleeve...	\$8.00
D366	1976-1977 Headlight Dimmer Instruc. Tag	\$8.00
D392	1975-1977 Instruction Sun Visor Start Sleeve...	\$8.50

Exterior Decals

D398	Buick Tri-Shield 1 1/2" Wheel Center Decal ...	\$8.00
D399	Buick Tri-Shield 2 7/8" Wheel Center Decal ...	\$8.50
D400	1970 Gas Cap Caution Decal (California Cars)....	\$8.50
D405	Unleaded Fuel Only 5" Straight - White	\$7.50
D406	Unleaded Fuel Only 5" Straight - Black.....	\$7.50
D407	Unleaded Fuel Only 4" Straight - Black & White	\$7.50
D408	Unleaded Fuel Only 4" Straight - Black & White	\$7.50
D410	Unleaded Fuel Only 3" Curved - White	\$7.50
D411	Unleaded Fuel Only 3" Curved - Black.....	\$7.50



www.oldbuickparts.com
908-369-3666

Emission Stickers

D128	1967-1969 430 Automatic transmission.....	\$8.50
D265	1968 Buick 430 - Automatic transmission.....	\$8.50
D309	1970 455 Automatic transmission.....	\$8.50
D62	1970 All with stage 1 engine.....	\$8.00
D294	1970 All V-8 "Evaporative control" decal	\$8.50
D102	1970 455 Stage 1 Automatic transmission - After 1/1/70	\$8.50
D290	1970 455 Stage 1 Automatic transmission Before 1/1/70	\$8.50
D270	1971 Buick GS 455 Automatic transmission...	\$8.50
D269	1971 Buick 455 Stage 1 Automatic and Manual transmission.....	\$8.50
D120	1972 455 Stage 1 - Automatic and Manual transmission	\$8.50
D307	1972 All 455	\$8.50
D312	1973 All 455	\$9.00
D313	1973 All 4555 Stage 1.....	\$9.00
D315	1974 455 4BBL Auto. Trans.....	\$9.00
D316	1974 455 Stage 1.Auto. Trans.....	\$9.00

Air Conditioning Tags

D379	1963 "Air Conditioned" Window decal	\$8.50
D172	1963 Compressor warning decal.	\$8.50
D297	1964 Frigidaire compressor sticker.....	\$9.00
D190	1965 Harrison air conditioner box sticker.....	\$8.50
D187	1965 Frigidaire compressor sticker.....	\$9.00
D191	1966 Harrison air conditioner box sticker.....	\$8.50
D251	1966 Frigidaire compressor sticker.....	\$9.00
D192	1967 Harrison air conditioner box sticker.....	\$8.50
D298	1967-1968 Frigidaire compressor sticker.....	\$9.00
D193	1968 Harrison air conditioner box sticker.....	\$8.50
D252	1969 Frigidaire compressor sticker.....	\$9.00
D194	1969 Harrison air conditioner box sticker.....	\$8.50
D253	1970 Frigidaire compressor sticker.....	\$9.00
D195	1970 Harrison air conditioner box sticker.....	\$8.50
D196	1971 Harrison air conditioner box sticker.....	\$8.50
D299	1971 Frigidaire compressor sticker.....	\$9.00
D197	1972 Harrison air conditioner box sticker.....	\$8.50
D189	1972 Frigidaire compressor sticker.....	\$9.00
D198	1973 Harrison air conditioner box sticker.....	\$8.50
D229	1973 Riviera Harrison Box #ABE 50A72A.....	\$5.75
D199	1974 Harrison air conditioner box sticker.....	\$4.25
D200	1975 Harrison air conditioner box sticker.....	\$8.50
D201	1976 Harrison air conditioner box sticker.....	\$4.25
D415	1977 Harrison air conditioner box decal. ACM-050-77B	\$9.00
D260	1978 Harrison air conditioner box decal. ACM-050-78B	\$9.00
D256	1978-1980 Delco A.C. compressor 1131198	\$9.00
D233	1979 Harrison air conditioner box decal. ACM-056C-798	\$9.00
D250	1980 Harrison air conditioner box decal. EBA-112-80B	\$9.00
D258	1981 Delco A.C. compressor 1131198	\$9.00
D255	1981 Harrison air conditioner box decal. 3042218	\$9.00

Cooling (Group 1)

Radiator Insulator

1963-1965 Radiator mounting rubber insulator. Lower.

RI614.....\$9.50 ea.

1966 All. Radiator support bracket insulator. Fully molded.

RI656.....\$47.99 pr.

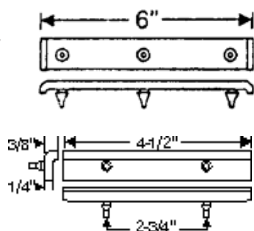

Radiator Hoses (1.159)



1963-1965 Riviera. Lower radiator hose. Formed.

LH429\$18.50 ea.

1963-1965 All. Formed upper hose.

UH625.....\$21.75 ea.

1969-1971 All. Upper.

RH980.....\$22.25 ea.

1971-1974 All. Lower.

RH648.....\$21.25 ea.

1972-1974 All. Upper.

RH869.....\$22.50 ea.

1982-1985 all with 307Y or 350N engine. Upper.

UH825R\$24.50 ea.

1982-1985 all with 307Y or 350N engine. Lower.

LH825R.....\$17.00 ea.



1934-1960 Radiator drain cock. Brass.

DV344.....\$5.75 ea.

Radiator Hose Clamps

These are authentic "Tower Top" hose clamps made by Wittek Company for GM. They are correct for all **1963-1990** models.

2 1/16" diameter - fits most upper hose.

HC216.....\$2.75 ea.

2 1/4" diameter - fits most lower hose.

HC214.....\$2.75 ea.

2" diameter - Where smaller clamp is desired..

HC200.....\$2.75 ea.



Thermostats

1963-1966 Riviera thermostat with gasket.

T536.....\$9.50 ea.

1967-1980 Riviera thermostat with gasket.

T330.....\$9.75 ea.



Water Outlets

1963-1966 Water outlet with gasket.

WO626.....\$29.50 ea.

WOG536.....(Gasket only).....\$2.25 ea.

WOB536..Bolts & Washers for Above..\$3.75 ea.



1967-1974 All. Engine block water outlet with gasket.

WO615.....\$25.50 ea.

WOG615.....(Gasket only).....\$2.25 ea.

WOB536..Bolts & Washers for Above..\$3.75 ea.



Radiator Caps

Take a good look at these Caps. They are identical to the originals. Correct in every detail, they feature the cap number, instructions and of course genuine "AC" identification stamped right into the cadmium plated surface. Show quality, approved and licensed by Buick.

1963-1964 All. 15 lb.

RC15D.....\$32.50 ea.

1965-1968 All. 15 lb.

RC15F.....\$32.50 ea.

1969-1970 All w/o coolant recovery system. 15 lb.

RC15H\$32.50 ea.



Radiator Cap Replacements

1963-1969 All. 15 lb.

RC579.....\$16.50 ea.

1970-1976 All.

RC706.....\$9.75 ea.

Heater Hose Clamps

Buick used "Tower Top" hose clamps on all cars from **1963-1975**. We supply the identical clamps made by the Wittek Company. They are authentic and correct. 1 1/16" for 5/8" heater hose.

HC580.....\$2.75 ea.

1" for use on thin walled 5/8" hose.

HC580S\$2.75 ea.

1 1/4" for 3/4" heater hose.

HC340.....\$2.75 ea.

1 3/16" for use on thin walled 3/4" hose.

HC340S\$2.75 ea.

Core Support Mounting Kit

1979-1985 All. 4 piece kit. 2 upper and 2 lower cushions.

CSK795.....\$51.00 ea.

Coolant Reservoir Cap

1980-1985 Riviera.

JC805.....\$8.00 ea.



Wire Hose Clamps**For 9/16" diameter hose.**

HC916W\$1.00 ea.
 HC916WP.....(5 Pack) ...\$3.25 ea.

For 3/4" diameter hose.

HC340W\$0.75 ea.
 HC340WP.....(5 Pack)\$3.25 ea.

For 13/16" diameter hose.

HC1316W\$1.00 ea.
 HC1316WP.....(5 Pack)\$4.25 ea.

For 15/16" diameter hose.

HC1516W\$0.75 ea.
 HC1516WP.....(5 Pack)\$4.25 ea.

For 1" diameter hose.

HC100W.....TOS
 HC100WP.....(5 Pack)\$4.25 ea.

For 1-1/4" diameter hose.

HC114W\$1.00 ea.
 HC114WP.....(5 Pack)\$5.00 ea.

For 2" diameter hose.

HC200W\$2.75 ea.
 HC200WP.....(5 Pack)\$2.25 ea.

**Fan Clutches**

1963-1976 Riviera thermal fan clutch.
 FC626\$64.50 ea.

**Water Pumps**

1963-1966 Riviera without air conditioning. Exchange.
 WP626RS.....\$79.00 ea.

1963-1966 Riviera with air

conditioning. This pump will also fit non- AC cars.

WP626A\$79.50 ea.

1967-1970 Riviera with air conditioning.

WP670\$80.25 ea.

1967-1972 Riviera without air conditioning.

WP672\$57.50 ea.

1971-1976**1971-1972** All with AC;**1973-1976** All.

WP716\$56.25 ea.

1977-1981 Riviera with 350 engine.

WP731\$58.75 ea.

Breather Tubes**(Air Cleaner to Rocker Cover)** (1.745)

Breather Tube

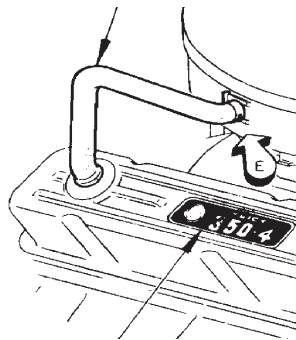
**1968-1969** All 350 and 400 4BBL.

VT689.....\$19.50 ea.

**1970-1971** all V-8; **1972** all 455 engines

VT704\$16.50 ea.

**Fan Belts**

1963-1976 Fan belts.
 (state all information).

FB400\$17.50 ea.

1963 All w/o AC.

FB1188358.....Exact Reproduction.....\$34.50 ea.

**Fan Shrouds** (1.277)

Fiberglass repro.

FS635.....**1963-1965 Riviera**\$169.50 ea.

FS670.....**1967-1970 Riviera w/ a.c**\$169.50 ea.

**Water Pump Mounting Gaskets****1963-1966** All.

WPG626\$3.75 ea.

1967-1975 All.

WPG675\$3.25 ea.

1976-1985 All 350, 350B, 350X engines.

WPG615\$3.50 ea.

Water Manifold Gasket Kit

1961-1966 All. Includes 2 gaskets and "O" ring.

WMK536.....\$9.50 ea.

**By-Pass Hoses****1967-1975** Thermostat by-pass hose.

BP676.....\$9.75 ea.

**Temperature Sending Units** (1.150)**1963-1967** All. (two terminals).

TSU608....(Dash light type)\$19.75 ea.

**1966-1968** Electric thermostat gauge.

TSU665.....\$19.50 ea.

**1969-1972** One terminal in intake manifold.

TSU662....(Dash light type)\$13.50 ea.

**1969-1974** All with switch in cylinder head.

TSU694....(Dash light type)\$16.50 ea.

Oiling (Group 1)

Oil Filters



1963-1966 All. (Also fits thru 1980 where there is room for taller filter). PF-7 type.
OF596\$11.00 ea.

1967-1980 All exc. V-6 and 260 engines.
PF-24 type.
OF670\$11.00 ea.



PF-24 Oil Filters

A brand new quality reproduction on the original 1967-1975 red, white, and blue, "AC TYPE PF-24" oil filter with logo and proper coloring. A must for the concours restorer.
OF590AC\$22.25 ea.

1979-1981 350R, engines;
1982-1985 All 307 engines.

Oil Pumps

1963-1966 Oil pump.
OP626.....\$189.50 ea.
1967-1975 430-455 engine, oil pump.
OP675.....\$59.25 ea.

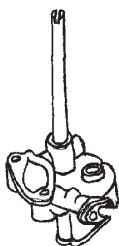

Oil Pump Kits

1963-1966 Oil pump kit.
OPK626\$69.50 kit
1967-1976 Oil pump kit.
OPK676\$39.50 kit
OPK676H.....High Volume Kit.....\$89.75 kit

Oil Pan

1967-1970 All. Center sump.
OP670.....\$179.00 ea.
1971-1976 455 All without factory crossover.
OP676.....\$179.00 ea.



Oil Pan Drain Plug and Gasket

1963-1975 1/2"-20 thread.
OP595\$5.50 ea.
ODG595.....Nylon Gasket Only.....\$2.50 ea.
ODG595C.....Crushable Copper Gasket.....\$3.00 ea.

Oil Pick-up Tube and Screen

Increased oil pick-up over stock 1/2" tube.
Gives 5-10 psi oil pressure increase.
1967-1970 engines require that pick-up passage drilled to 5/8". Acts as replacement for **1970** and later engines.



1962-1966 GS 400, 401, 425 engine. Stock size.
OPU626\$155.00 ea.
1967-1975 All 400, 430 and 455 engines.
OPU675\$82.75 ea.
1967-1975 350 engines.
OPU695\$20.00 ea.

Oil Pressure Switches (1800)



1963-1966 Oil pressure switch.
OPS606.....\$11.75 ea.



1968 Oil pressure switch.
OPS620.....\$13.75 ea.



1969-1970 Oil pressure switch.
OPS690.....\$12.50 ea.



OC397A



OC397 & OC647



OC684

Oil Filler/Breather Caps

1963-1967 All except Chrome jobs. Genuine "AC OIL" Exact Reproduction. Show quality.
OC397\$29.50 ea.
1963-1967 All except chrome jobs. Twist type. Replacement.
OC397A.....\$9.75 ea.
1964-1967 "AC OIL" chrome twist on cap.
 1964-1966: GS with 2-4 carbs;
 1967: with engine dress up kit.
OC647\$34.50 ea.
1968-1974 All (Twist on type).
OC684\$4.75 ea.

Distributor Gear Oiler

1967-1976 all 400, 430 and 455. This modification increases the life of the distributor gear and cam gear - a must since the cam gear is not replaceable. Provides constant supply of oil spray to both gears. Modification requires small hole to be drilled and tapped on the inside of timing chain cover. Oil pressure is not affected. Requires 1/8" pipe tap and 2-1/64 drill bit not supplied in kit. Instructions included.
GO676.....\$19.50 ea.



Oil Pump Covers

1967-1976 All 430, 455 engines.
OPC646.....\$89.50 ea.
OCG647.....gasket for above.....\$4.75 ea.
1974-2009 All 3.8 (231), 4.1 (252) metric engines.
OPC749.....\$89.50 ea.



Rocker Cover Plug

1964-1967 Solid rocker cover plug.
CP647.....\$11.75 ea.

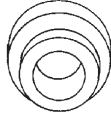

Oil Gaskets

1963-1966 All. Oil pan gasket.
OPG576.....\$15.00 ea.
1967-1976 All. 430 and 455 oil pan gasket.
OPG676.....\$19.00 ea.
1963-1966 All. Oil pan drain plug gasket.
ODG615\$2.25 ea.
1967-1975 All. Oil pan drain plug gasket.
ODG675\$2.25 ea.
1963-1966 All. Rear main bearing seal set. Rubber lip.
RMS576.....\$24.75 ea.
1963-1966 All. Rear main bearing seal set. Rope type.
RMS346.....\$14.00 ea.
1967-1975 All. Rear main bearing seal set.
RMS615.....\$12.75 ea.
1977-1980 All. 350 Engines.
OPG645.....\$10.75 ea.

PCV Valves

1963-1975 All. PCV valve.
PCV635.....\$6.75 ea.



Oil Pump Thrust Plate Repair Kit



This kit provides a NEW WEARING surface for badly scored or worn cover housing. Kit contains all necessary screws, gaskets and instructions.

1967-1976 All.
OPK685\$ 32.50 ea.

ZDDP Oil Supplement - 4 oz. Bottle



ZDDPlus is a oil additive that contains high concentraions of Zinc Diakyl Dithiophosphate, which has been the primary extreme pressure ingredient now missing from modern day motor oils. This is a must in all flat-tappet engines!

ZDDP.....\$14.00 ea.

ZDDP5.....(5 bottles).....\$39.95



Crankcase Vent Hose (to Carb)

1967 400, 430:
1968-1971 All 4BBL engines.
VH671.....\$28.00 ea.

1972-1975 All. (Formed hose).
VH725.....\$24.50 ea.



Air Cleaner to Rocker Cover Vent Tubes (1.745)

1968-1969 All.
VT689.....\$19.50 ea.

1970-1971 All.
VT704.....\$19.50 ea.



Oil Pick-up Tube and Screen

1967-1976 400,455 w/ rear sump. (Increased oil pick-up over stock 1/2" tube. Gives 5-10 psi oil pressure increase. 1967-1970 engines require that pick-up passage drilled to 5/8". Acts as replacement for 1970 Stage 1 and all 1971-1976 455 engines).

OPU676R.....\$69.75 ea.

1967-1976 400,430,455 w. center sump. 5/8" Tube. Requires passage drilled to 5/8"
OPU676C\$74.50 ea.



Adjustable Oil Pressure Regulator

1961-1972 All. Regulate your oil pressure by adjusting tension on relief spring. Allows for safe and easy adjustment externally.

OPR600.....\$38.00 ea.



Oil Gaskets

	1961-1966 364, 400, 401 and 425 Engines	1964-1981 300, 340 and 350 Engines	1967-1976 400, 430 and 455 Engines
Oil Pan Gasket	OPG576.....\$14.50	OPG645.....\$11.50	OPG676.....\$19.00
Oil Pan Drain Plug Gasket	ODG595.....\$2.25	ODG595.....\$2.25	ODG595.....\$2.25
Rear Main Bearing Seal Set	RMS576..Rubber Lip type.....\$19.50 RMS346.....Rope type.....\$15.50	RMS615.....\$19.50	RMS615.....\$19.50

Electrical (Group 2)

Battery Parts

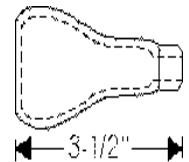

1963-1975 Battery terminal cable cover.
2 per car.
CC315\$6.75 ea.

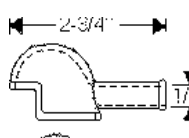

1963-1975 (+) Terminal and junction block cable cover.
CC325.....\$6.75 ea.

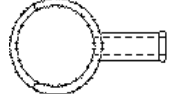

Battery Cables



Our replacement **battery cables** listed below for **TOP POST** batteries are made with heavy duty two (2) gauge copper wire.



Years	Replacement Cables	
	(+) Positive Price	(-) Negative Price
1963-1966	BC30.....\$25.25 ea.	BC24.....\$19.50 ea.
1967-1970	BC72.....\$51.00 ea.	BC24.....\$19.50 ea.
1971-1975	BC48.....\$34.50 ea.	BC31.....\$27.50 ea.

Genuine "Spring Ring" Sets

Our reproduction "**Spring Ring**" cables are made from GM blueprints to be identical to the originals in fit and functions. They are sold in pairs. "Spring Ring" cables are also sold individually. **Inquire!**



Wire Loom

Asphalt coated fabric. Wire loom for battery cables, headlamps, wire etc.



WL1801/8" ID\$1.85 ft.
WL3163/16" ID\$1.85 ft.
WL1401/4" ID\$2.10 ft.
WL5165/16" ID\$2.10 ft.
WL3803/8" ID\$2.10 ft.
WL7167/16" ID\$2.10 ft.
WL1201/2" ID\$2.10 ft.
WL9169/16" ID\$2.40 ft.
WL5805/8" ID\$2.40 ft.
WL3403/4" ID\$2.40 ft.

Nylon Wire Loom



NWL1401/4" ID\$1.50 ft.
NWL3803/8" ID\$6.50 5 ft.
NWL1201/2" ID\$6.00 4 ft.
NWL3403/4" ID\$1.75 ft.

Wiring Harness Tape



Non-adhesive vinyl harness wrap is same as used by GM. 1" wide, 100 foot roll.

WT1001" wide\$11.25 roll
-------	--------------	-------------------

Battery Clamps

1963-1970 Clamps feature rubber coating as original.



1963-1965 All Rivieras.
BC635.....\$29.50 ea.



1966-1967 All Rivieras.
BC667.....\$29.50 ea.



1968-1970 All Rivieras.
BC670.....\$29.50 ea.



1971-1976 All.
BC682.....\$4.00 ea.



Bolt for above.
BB682.....\$2.50 ea.

Battery Bolts



1963-1965 All Rivieras. Includes washers and nuts.
BB635.....\$6.50 ea.



1966-1970 All Rivieras. Includes washer and nuts.
BB610K.....\$7.00 ea.

Your Buick is mighty "Choosey" about the company it keeps.....
Treat it to the Best.
Use only Cars
Quality Original and
Reproduction Parts

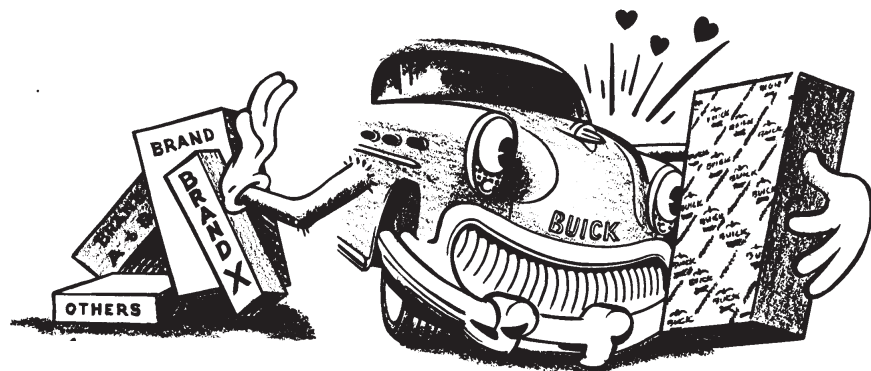

Starter Rebuilding Service

Check NOS Section
Group 2.041 for outright sales

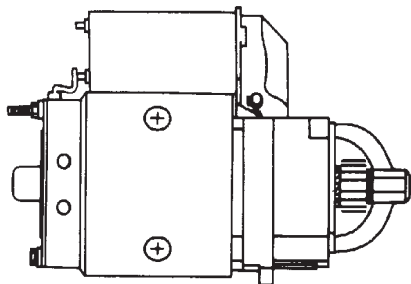

- 1963**
Riviera.
S623\$189.50 ea.
- 1964-1966** Riviera. (\$25.00 core charge).
S646RS\$189.50 ea.
- 1967-1974** Riviera. (\$25.00 core charge)
S674\$129.50 ea.

Heat Shield Starter Motor



- 1968-1976** All V-8 engines.
SS686\$39.00 ea.

Starter Drives



- 1963** All.
SD623\$39.50 ea.
- 1964-1975** All engines.
SD615\$24.50 ea.

Starter Solenoids



- 1963-1975** All engines.
SS575\$53.00 ea.

Starter Brush Sets



- 1963-1974** All.
SBS539\$6.50 set

Starter Solenoid Repair Kits



- 1963-1975** All.
SRK570\$24.50 kit

Starter ID Tag



- 1963** Delco, starter and distributor ID tag.
ET12\$7.00 ea.

Voltage Regulators



- 1963-1972** All except heavy duty. 62, 80 amp alternators.
VR622\$29.50 ea.
VR622E.....Electronic Replacement\$23.75 ea.
- 1963-1972** All except 1966 and 1967. Heavy duty 62-80 amp alternators. Genuine Delco.
VR622D\$79.50 ea.
- 1965-1975** All with heavy duty 62-80 amp alternators.
VR655\$19.50 ea.

Wire and Cable Retainers



- 1963-1972** Engine compartment wiring strap.
WS5.....7" long.....\$1.50 ea.
- 1963-1972** Engine compartment wiring strap.
WS6 2 3/4" Black.....\$0.85 ea.
WS7 4" Black.....\$0.85 ea.
WS8 4 1/2" Black.....\$0.85 ea.
WS9 8 3/4" Black.....\$0.85 ea.

Wire and Cable Retainers



- 1963-1966** Side frame rail wire retainers.
WR616.....\$5.00 ea.



- 1967-1972** All. Retains positive battery cable to side frame rail.
WR672\$3.25 ea.

Complete Tune-up Kit

1963-1966 All.	
TK617	\$94.50 kit
TK576	\$94.50 kit
1967-1970 All.	
TK671	\$94.50 kit
1971-1974 All.	
TK684	\$94.50 kit

Tune-up Parts



1963-1974 Ignition points.
D106.....\$16.50 ea.



1963-1974 Combination Ignition points and condenser.
IPC573



1963-1973 Condenser.
D204.....\$6.00 ea.



1963-1974 Distributor cap.
D308.....\$13.50 ea.
D308R..."Delco Remy" Repro...\$51.75 ea.



1963-1974 Ignition rotor.
D409.....\$7.50 ea.



1963-1966 Ignition wire set.
IW576



1967-1973 All; 1974 All except HEI.
IW674

Ignition Coils



1963-1973 All. Ignition coil.
IC539

1963-1973 Delco ignition coil.
IC539D

Universal Coil Bracket



CB350.....\$6.50 ea.
CB350C.....(Chrome).....\$11.50 ea.

Coil Resistor



1963-1974 All.
CB533.....\$11.50 ea.

Wiring Harness Tape



Non-adhesive vinyl harness wrap is same as used by GM. 1" wide, 100 foot roll.
WT100.....1" wide.\$11.25 roll

Signal Flasher



1961-1975 All.
SF615.....\$4.25 ea.

Spark Plugs



1963-1966 All.	
SPR43S.....	\$2.95 ea.
1967-1971 All.	
SP44TS.....	\$2.95 ea.
1972-1974 All.	
SP44TS.....	\$2.95 ea.

Genuine Delco Ignition Wire Sets



1967-1972	
1967: 430 engines;	
1968-1973: All.	
IW672D	\$42.50 set

See next page for date coded wire sets

Spark Plug Wire Parts



1963-1967 Spark plug boots (8 per car). For use with original type copper core ignition wires.
SB577



1963-1966 Ignition wire retainer (on rocker covers). Two per car.
WR596



1968-1973 All. Ignition wire retainer. Two per car.
WR683



1967-1973 All. Ignition "3" wire retainers. Two per car.
WT373



Distributor Knock Sensor

1983-1987	
1983-1984 with 4.1-4;	
1983-1985 with 231-8, 231-9;	
1986-1987 All	
KS838	\$36.00 ea.

Turn Signal Lever



1984-1985 All with pulse wipers and cruise.
TSL849C.....\$129.50 ea.

Electrical (Group 2)



<u>Year</u>	<u>Cars No.</u>	<u>Price</u>
1964	IS64.....	\$32.50 ea.
1969-1975	All tilt wheel	
	IS699T.....	\$29.50 ea.
1969-1975	All without tilt wheel	
	IS699.....	\$34.50 ea.

Ignition Lock Cylinder with Keys



<u>Year</u>	<u>Cars No.</u>	<u>Price</u>
1963-1964	IL414	\$22.50 kit
1965	IL65	\$22.50 kit
1966-1967	IL667	\$22.50 kit
1968	IL68	\$22.50 kit
1969-1978	IL695	\$22.50 kit
1979-1991	IL791	\$22.50 kit



Key Blanks (Genuine GM)



1963-1966 Door and Ignition - octagon. KB10.....	\$4.50 ea.
1963-1966 Glove and trunk - rounded. KB11.....	\$4.50 ea.
1967 & 1971 Door and ignition - rectangular. KB48.....	\$3.50 ea.
1967 & 1971 Glove and trunk - oval. KB49.....	\$3.95 ea.
1968 & 1972 Door and ignition - rectangular. KB50.....	\$3.50 ea.
1968 & 1972 Glove and trunk - oval. KB51.....	\$3.50 ea.
1969 & 1973 Door and ignition - rectangular. KB44.....	\$3.50 ea.
1969 & 1973 Glove and trunk - oval. KB45.....	\$3.50 ea.
1970 Door and Ignition - rectangular. KB46.....	\$3.50 ea.
1970 Glove and trunk - oval. KB47.....	\$3.50 ea.
1974 Ignition - rectangular. KB46.....	\$3.50 ea.
1974 Glove, door and trunk - oval. KB47.....	\$3.50 ea.

1975, 1979, 1983, 1985 Ignition - rectangular. KB48.....	\$3.50 ea.
1975, 1979, 1983, 1985 Glove, door and trunk - oval. KB49.....	\$3.50 ea.
1976 & 1980 Ignition - rectangular. KB50.....	\$3.50 ea.
1976 & 1980 Glove, door and trunk - oval. KB51.....	\$3.50 ea.
1977 & 1981 Ignition - rectangular. KB44.....	\$3.50 ea.
1977 & 1981 Glove, door and trunk - oval. KB45.....	\$3.50 ea.
1978 & 1982 Ignition - rectangular. KB46.....	\$3.50 ea.
1978 & 1982 Glove, door and trunk - oval. KB47.....	\$3.50 ea.

Key Caps



1967-1985 All oval keys. KC6700.....	\$1.50 ea.
--	------------



www.oldbuickparts.com

Never Change Points Again!

Upgrade to an electronic ignition. Fits entirely inside the distributor.
 Installs as quickly as changing a set of points. No black boxes,
 complicated wiring or special brackets. Only two wires to connect.

IGNITOR ELECTRONIC IGNITION KITS	NO.	PRICE
---	------------	--------------

8 CYLINDER

1937-1953 All Straight 8, 6 volt, negative ground	PI1183N6	\$125.00
1937-1953 All Straight 8, 12 volt, negative ground (original distributor)	PI1183	\$192.00
1953-1956 All V-8 Mechanical advance under baseplate	PI1185LS	\$99.50
1957-1974 All V-8 Except 215, 300, 340 Engines	PI1181LS	\$95.00
1957-1974 All V-8	PI1181	\$95.00
1957-1974 All V-8 (Ignitor II)	PI91181	\$122.00

6 CYLINDER

1968-1974 All	PI1162A	\$99.00
1962-1967 V-6 Engine	PI1164	\$99.00
1962-1967 V-6 Engine (Odd Fire)	PI1165	\$99.00

HIGH PERFORMANCE COIL

1937-1953 All Straight 8, 6 volt, negative ground (Black)	PC45011	\$39.50
1937-1953 All Straight 8, 6 volt, negative ground (Chrome)	PC45001	\$49.50
1953-1974 All (Black)	PC40011	\$39.50
1953-1974 All (Chrome) 12 v	PC40001	\$46.50
1953-1974 All (For Ignitor II applications only - Chrome) 12 v	PC45001	\$49.50
1953-1974 All (For Ignitor II applications only - Black) 12 v	PC45011	\$39.50
Coil Bracket	CB350	\$6.50
Coil Bracket (Chrome)	CB350C	\$11.50

HIGH PERFORMANCE SPARK PLUG WIRES

Low 500 ohm/ft. resistance with spiral wound alloy to suppress electromagnetic radiation plus redundant current paths.

V-8 7.0mm Stock-Look Custom Set

1953-1960 All	PW708103	\$46.50
1960-1967 Special, Skylark, GS (Ex 1967 GS 400)	PW708103	\$46.50
1967-1966 LeSabre, Wildcat, Invicta, Electra, Riviera All 364, 401, 425 Engines	PW708105	\$44.50
1967 GS-400	PW708102	\$44.50
1968-1974 All 350, 400, 430, 455 w/o HEI	PW708102	\$44.50

6 CYLINDER 7.0mm STOCK-LOOK Custom Set

1968-1974 ALL	PW706101	\$44.50
---------------------	----------	---------

1963-1974 Buick Riviera - Date Coded Spark Plug Wires

For those requiring the best for their show ready car, these reproduction wire sets are unsurpassed. They are manufactured to original GM blueprint specifications. They include the proper boots, terminals, script and correct factory length. All wires are carbon core for radio suppression. They come correctly identified with "**Packard Radio TVRS**" or "**Radio GM**" along with the proper date code to match your car.

Date codes will read as such: 3 Q 67. The first number, "3" corresponds to the third quarter of the year. "Q" means quarter. The last number, "67", is the year, 1967. Thus, a cable marked 3 Q 67 was produced in the third quarter of 1967. You should order your spark plug wire sets with dates that are 6 to 12 months prior to the manufacturing date of your car. *Note:* wires were not dated on vehicles prior to January 1961. Reproduction Spark Plug Wire Sets - 8 Cylinder

PART NO.	DATE	YEAR	DESCRIPTION	PRICE
W3330623	3-Q-62	1963	Spark Plug Wires, V8 All	\$79.50 set
W3330631	1-Q-63	1963	Spark Plug Wires, V8 All	\$79.50 set
W3330633	3-Q-63	1964	Spark Plug Wires, V8 All	\$79.50 set
W3330641	1-Q-64	1964	Spark Plug Wires, V8 All	\$79.50 set
W3330643	3-Q-64	1965	Spark Plug Wires, V8 All	\$79.50 set
W3330651	1-Q-65	1965	Spark Plug Wires, V8 All	\$79.50 set
W3332653	3-Q-65	1966	Spark Plug Wires, V8 All	\$79.50 set
W3332661	1-Q-66	1966	Spark Plug Wires, V8 All	\$79.50 set
W3342663	3-Q-66	1967	Spark Plug Wires, V8 All	\$79.50 set
W3342671	1-Q-67	1967	Spark Plug Wires, V8 All	\$79.50 set
W3342673	3-Q-67	1968	Spark Plug Wires, V8 All	\$79.50 set
W3342681	1-Q-68	1968	Spark Plug Wires, V8 All	\$79.50 set
W3342683	3-Q-68	1969	Spark Plug Wires, V8 All	\$79.50 set
W3342691	1-Q-69	1969	Spark Plug Wires, V8 All	\$79.50 set
W3342693	3-Q-69	1970	Spark Plug Wires, V8 All	\$79.50 set
W3342701	1-Q-70	1970	Spark Plug Wires, V8 All	\$79.50 set
W3342703	3-Q-70	1971	Spark Plug Wires, V8 All	\$79.50 set
W3342711	1-Q-71	1971	Spark Plug Wires, V8 All	\$79.50 set
W3344713	3-Q-71	1972	Spark Plug Wires, V8 All	\$79.50 set
W3344721	1-Q-72	1972	Spark Plug Wires, V8 All	\$79.50 set
W3344723	3-Q-72	1973	Spark Plug Wires, V8 All	\$79.50 set
W3344731	1-Q-73	1973	Spark Plug Wires, V8 All	\$79.50 set
W3344733	3-Q-73	1974	Spark Plug Wires, V8 All Exc Hei	\$79.50 set
W3344741	1-Q-74	1974	Spark Plug Wires, V8 All Exc Hei	\$79.50 set

Distributor Rebuilding Service

See NOS Group 2.361
Section for outright Sale

- 1963-1966 All.
- D596\$167.50 ea.
- 1967-1974 All.
- D674\$167.50 ea.



(2.410)

Vacuum Advances

- 1963-1974 All. Distributor vacuum advance. Oem type.
- VC600\$17.50 ea.

Horns

- 1961-1999 All. (replacement type) May not look the same as original. Bracket and wire as necessary.
- H610L.....(Low Note).....\$59.50 ea.
- H610H.....(High Note).....\$59.50 ea.

Horn Blowing Contact Spring



- 1969-1974: All.
- HS666\$7.75 ea.

Horn Relays (2.815)



- 1963-1967 All with junction block.
- HR617\$87.50 ea.



- 1965-1968 All with relay only.
- HR658\$17.50 ea.



- 1968 All little fuse.
- HR658L\$39.50 ea.

Turn Signal Switches

- 1967-1968 All w/o tilt wheel. Delco color code white or green. Includes wiring.
- DSS678.....\$45.00 ea.
- 1969-1972 All w/o cornering lamps. Includes wiring.
- DSS696.....\$46.75 ea.
- 1976-1990 Headlamp dimmer actuator. All with tilt or tele.
- HDA760\$4.75 ea

Alternators

- 1963-1971 All 61 amp. Exchange.
- A631.....\$72.25 ea.



Alternator Brush Sets



- 1963-1967 all except 62 amp. alternators;
- 1968 thru 1971 all
- ABS621\$12.75 set
- 1964-1967 all 62 amp. alternators.
- ABS647\$7.75 set

- 1963-1971 Alternator rear end bearing (62 amp. jobs).
- GEB581\$15.75 ea.

- 1963-1971 Alternator front bearing.
- GEB581\$15.75 ea.

- 1963-1975 Alternator rear bearing (ex. 62 amp).
- GEB633\$17.50 ea.

- 1972-1980 Alternator front bearing.
- GEB713\$11.25 ea.

Alternator Contact Rubber Boot



- 1963-1972 All.
- AB632\$4.50 ea.

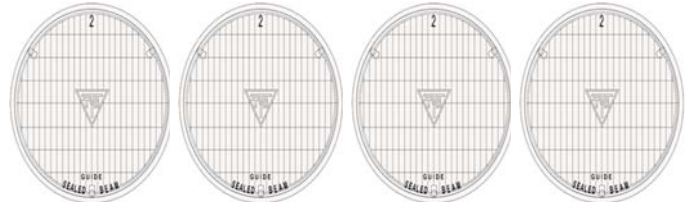

Genuine Guide T-3 Headlight Bulbs

- SB607S.....1963-1967 All.....\$149.00 set of four (4)
- SB681S.....1968-1971 All.....\$149.00 set of four (4)

Headlight Bulb Retainer



- 1967-1973 All as required. 3 tabs. For 4 headlight systems.
- HR683\$9.50 ea.

Electrical (Group 2)

1965, 66, 67 Headlamp Motor Repair

Complete reconditioning of your headlamp motor. Does not include switches. Lifetime warranty. Exceeds OEM performance.

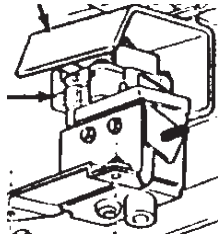

HM667.....(1966-1967).....\$346.50 ea.

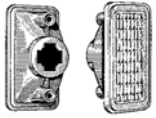

1968-1969 Front marker lamp.
MLF689\$16.50 ea.



1968-1969 Front marker lamp gasket.
Small rectangular.
MLG689.....\$4.00 ea.



1971-1973 Rear marker lamp gaskets.
MLG713R.....\$9.75 pr.

Headlamp Visor Relay

1965 All.

HVR65.....\$17.50 ea.



Turn Signal Levers

1969-1970 Buick Special, Skylark, Sportwagon, GS.
Correct Fluted ChromeLever With Black Knob.
All Without Cruise Control.

TSL690.....\$29.00 ea.

1969-1970 All With Cruise Control.

TSL670C.....\$109.00 ea.



1971-1976 All w/ Cruise Control.
Correct Chrome Lever w/ Black Knob.
TSL716.....\$109.00 ea.

1963 -1964 Parking Lamps



1963-1964 Park Lamp Lenses.
Outer lenses, clear w/ no markings. Either side.
PL634R.....\$119.00 ea.



1963-1964 Front Parking Lamp Lenses Grill.
Diecast chrome as original, fits either side.
LG634.....\$249.50 ea.
Set of 6 count screws for above.
LGS634.....\$2.25 set

Parking Lamp Gaskets



1963-1964 Riviera front parking lamp lens gaskets.
PLG634R.....\$9.00 ea.

1965 Riviera front parking lamp lens gaskets.
PLG65R.....\$12.75 pr.

Headlamp Switches



HS593.....**1963** All.....\$49.50 ea.
HS647.....**1964** thru **1967** All.....\$28.50 ea.
HS685.....**1968** thru **1977** All exc.....\$25.50 ea.
HC645....(connector plug for 1964-1977 above)..\$9.75 ea.
HS805R.....**1980** thru **1985** exc. twilight sent....\$30.25 ea.

Headlight Dimmer Switch



1963-1975 All except guidematic.
HDS615.....\$9.00 ea.

1961-1967 All. Sealed beam retainer screw.
6 per car.
HS400.....\$1.25 ea.

Headlight Support Pads



1970-1975 Headlamp assembly to core support pads. White nylon. 12 per car.
HP705.....\$2.25 ea.
HP705S.....(Set of 12).....\$20.50 set

Headlight Bezel Nuts



1964-1968 All. Headlamp bezel retaining nut.
HBN649.....\$2.25 ea.

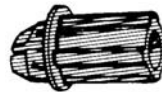

1969-1972 Headlamp bezel retaining nut.
HBN692.....\$2.75 ea.
HBN692S.....(Set of 8).....\$19.50 set



1969-1974 Headlamp adjustment nut.
HBN649.....\$4.00 ea.

Sealed Beam Headlamps



1975-1990 All as required.

Rectangular - for 4 lamp systems.

SB4561.....2 prong high beam.....\$13.75 ea.
SB4652.....3 prong low beam.....\$13.75 ea.

Halogen Bulbs

SB4561H.....2 prong high beam.....\$15.75 ea.
SB4652H.....3 prong low beam.....\$15.75 ea.

1963-1964 Tail Lamp Bezels

These difficult to find and nearly impossible to rechrome Bezels have been finally reproduced to the same quality as original.



- 1963-1964 Riviera tail lamp chrome bezel.
TB634\$149.50 ea.
- 1963-1964 Riviera tail lamp bezel gasket. Economical extrusion.
TBE634\$17.50 pr.



- 1963-1964 Riviera tail lamp bezel gasket. 1 piece molded rubber.
TBG634.....\$17.50 ea.
- 1963-1964 Riviera tail lamp bezel gasket. Economical extrusion.
TBG634S\$17.50 pr.

1965 Tail Lamp Bezels



- 1965 Die cast chrome. Show quality.
TB65\$197.50 ea.

Tail Lamp Gaskets



- 1963-1964 Tail Lamp Gasket (2.684) Riviera tail lamp lens gaskets.
TLG634R\$12.75 pr.
- 1965 Riviera tail lamp lens gaskets.
TLG65R.....\$17.00 pr.
- 1965 Riviera tail lamp to body gaskets.
TLP65R\$17.00 pr.
- 1966-1967 Riviera tail lamp lens gaskets.
TLG667R\$19.50 pr.
- 1966-1967 Riviera tail lamp to body gaskets. 8 per car.
TLS667R\$3.75 ea.
- 1968 Riviera tail lamp lens gaskets.
TLG68R\$30.79 pr.

1963-1964 Tail Lamp Lens and Medallions

These are totally new Reproductions at very reasonable prices. In fact these Lenses are far superior to any seen yet. They are 100% correct and feature all markings, such as "GUIDE", along with the proper Buick part number imprinted right into the lens. They also incorporate the additional and necessary reflective lenses needed for safety and Authenticity.

Medallions are also new, made of die cast metal and beautifully chrome plated to be identical to originals.

1963 Riviera Tail Lamp Lenses

(Lens & Medallion) Fits either side.



TL63R



TL63RP

- TL63R.....Complete Assembly\$68.50
- TL63RP.....Lens Only.....\$59.50
- TLE63R.....Medallion Only\$24.50

1964 Riviera Tail Lamp Lenses

(Lens & Medallion). Fits either side.



TL64R



TL64RP

- TL64R.....Complete Assembly\$68.50
- TL64RP.....Lens Only.....\$59.50
- TLE64R.....Medallion Only\$24.50

Back-up Lamp Parts



- 1966-1967 Back-up lamp rubber bumpers.
GDB635.....\$5.00 pr.

License Lamp Gaskets (2.707)



- 1964 License lamp lens gasket.
LLG624.....\$4.25 ea.



- 1965;
1968-1972 All. License lens gasket.
LLG643.....\$6.75 ea.

- 1969-1972 All. License lamp lens.
LL682.....\$10.25 ea.



Electrical (Group 2)



Bulbs



Year & Model	Head-light	Parking	Direction Signal		Tail	Stop	License Plate	Instrument	Indicator	Dome	Back-up	Marker lamp	
			Front	Rear								Left	Right
1963	SB1, SB2	B1034	B1034	B1034	B1034	B1034	B67	B57161	B194	B901004	B1073	----	----
1964	SB1, SB2	B1157A	B1157	B1157	B1157	B1157	B97	B161194	B194	B901004	B1156	----	----
1965	SB1, SB2	B1157A	B1157A	B1157	B1157	B1157	B97	B161194	B194	B901004	B1156	----	----
1966	SB1, SB2	B1157A	B1157A	B1157	B1157	B1157	B97	B194	B194	B901004	B1156	----	----
1967	SB1, SB2	B1157A	B1157A	B1157	B1157	B1157	B97	B194	B161	B211	B1156	----	----
1968	SB1, SB2	B1157A	B1157A	B1157	B1157	B1157	B97	B1941893	B194	B901004	B1156-1157	B194A	B194
1969	SB1, SB2	B1157A	B1157A	B1157	B1157	B1157	B97	B1811893	B194	B901004	B1157	B194A	B194
1970	SB1, SB2	B1157A	B1157A	B1157	B1157	B1157	B97	B181194	B194	B211	B1157	B194A	B194
1971	SB1, SB2	B1157A	B1157A	B1157	B1157	B1157	B97	B161194	B194	B211	B1157	B194	B194
1972	SB1, SB2	B1157A	B1157A	B1157	B1157	B1157	B97	B161194	B194	B211	B1157	B194	B194
1973	SB1, SB2	B1157A	B1157A	B1157	B1157	B1157	B97194	B194	B194	B211	B1157	B194	B194
1974	SB1, SB2	B1157A	B1157A	B1157	B1157	B1157	B194	B168	B194	B211	B1157	B194	B194
1975	SB1, SB2	B1157A	B1157A	B1157	B1157	B1157	B194	B168	B161	B211	B1157	B194	B194
1976	SB1, SB2	B1157A	B1157A	B1157	B1157	B1157	B194	B168	B161	B211	B1157	B1157A	B1157
1977	SB1, SB2	B1157A	B1157A	B1157	B1157	B1157	B168	B161	B161	B56189	B1156	B194A	B168
1978	SB1, SB2	B1157A	B1157A	B1157	B1157	B1157	B168	B161	B161	B56189	B1156	B194A	B168

Prices: 53-\$1.50, 57-\$1.25, 67-\$1.50, 90-\$2.00, B97-\$2.25, 161-\$2.00, 168-\$1.50, 194-\$2.25, 194A-\$3.00, 210-\$5.50, 211-\$2.25, 1004-\$2.75, 1034-\$2.75, 1073-\$2.75, 1156-\$2.50, 1157A-\$2.00, 1157-\$2.00, 1893-\$2.25, SB1-\$11.25, SB2-\$11.25

NOTICE

CAR SHOW ATTENDEES

CARS, Inc. will NOT bring the usual "yellow trailer" to the shows.

We will be happy to bring any parts you need.

Please call in advance of the show to place your order.

Look For Us!

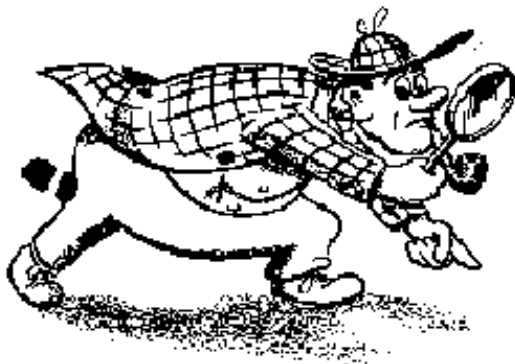

If your thinking of attending any of the shows listed below, be sure to stop by and say "Hello". We will be glad to discuss some of our newest items or simply talk about your **BUICK**.

Plan ahead by calling-in your order weeks ahead of time. We will be able to bring your entire order and save you shipping too.

GS Nationals
Buick Nationals
**Hershey* *GDB 31*
near Lamp Post 86

Headlamp Sockets



For 3 prong beam numbers SB6, 6006, SB12, 6012, SB2, 4000 and 4002.
PT6\$4.75 ea.



For 2 prong beam numbers SB1, 4001.
PT7\$4.25 ea.

Lamp Sockets and Pigtails



Single contact with lead. Fits bulb numbers 51, 53, 55 and 57.
PT1\$2.25 ea.



Single contact with lead. Fits bulb numbers 63, 67, 81, 87, 89, 1073, 1129, 1133, 1141 and 1156.
PT2\$2.25 ea.



Double contact with lead. For ears reversed. Bulbs numbers 82, 88, 90, 210, 1004, 1034, 1154 and 1157.
PT3\$2.75 ea.



Double contact with lead. For ears aligned bulbs.
PT4\$2.50 ea.

Parking and Tail Lamp Sockets

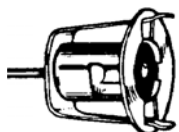

Single contact with lead. For 3/4" to 1 1/8" hole.
LS1\$5.75 ea.

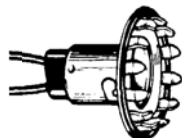

Double contact with lead. For bulb numbers 1034 and 1154. Fits 1 1/8" hole.
LS5\$5.75 ea.

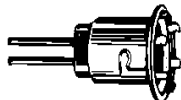

Double contact with leads. Fits 3/4" hole. For bulb numbers 1034, 1154 and 1157.
LS9\$5.75 ea.



Double contact with leads. Fits 3/4" to 1 1/8" hole. For bulb numbers 1034, 1154 and 1157.
LS2\$5.75 ea.



Double contact with leads. Fits 3/4" to 1 1/8" hole. For bulb numbers 82, 88, 90, 210 and 1004.
LS3\$7.75 ea.



Double contact with leads. Fits 1 1/8" hole. For bulb numbers 1034, 1154 and 1157.
LS4\$5.75 ea.

Interior/Dash Sockets



Single contact with lead for dome etc. For bulb numbers 63, 67, 81, 89, 1073, 1129 and 1133.
PT8\$6.75 ea.



Double contact with lead. For dome and map lamps. Reversed ears. Bulb numbers 82, 88, 90, 210 and 1004.
PT9\$6.75 ea.



Double contact with lead for ears aligned bulbs.
PT10\$4.75 ea.

Back-Up and License Lamp Sockets

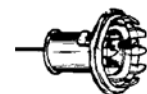

Single contact with lead. Fits 3/4" hole. Bulb numbers 63, 67, 81, 89, 1129 and 1133.
LS6\$6.00 ea.



Single contact with lead. Fits 1 1/8" hole. For bulb numbers 63, 67, 81, 89, 1129 and 1133.
LS8\$6.00 ea.

Wire Loom

Asphalt coated fabric. Wire loom for battery cables, head lamps, wire etc.



WL180	1/8" ID	\$1.85 ft.
WL316	3/16" ID.	\$1.85 ft.
WL140	1/4" ID	\$2.10 ft.
WL516	5/16" ID	\$2.10 ft.
WL380	3/8" ID.	\$2.10 ft.
WL716	7/16" ID	\$2.10 ft.
WL120	1/2" ID.	\$2.10 ft.
WL916	9/16" ID	\$2.40 ft.
WL580	5/8" ID	\$2.40 ft.
WL340	3/4" ID.	\$2.40 ft.

Carburetion (Group 3)

Carburetor Rebuilding and Restoration Service (3.725)

Each carburetor is totally disassembled and cleaned in a hot tank solution. Then, each component is correctly plated, painted and colored to duplicate it's original factory finish. The carburetor is reassembled using all proper gaskets, pumps, needles and seats, etc. and new correct screws. Finally, all bench adjustments are made to factory specs. This includes correct shimming of the start switch. The result, the best rebuilt and restored carburetor available in the Hobby.

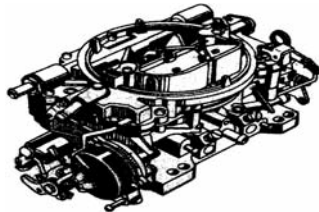

NOTE: This is not an area to skimp on your restoration. Demand the best!

- 1963-1980** All 2bbl Carburetors w/ Bakelite switch.
CRS390.....\$379.50 ea.
- 1963-1980** 4bbl. Carburetor rebuilding service.
CRS520.....\$389.00 ea.
- 1964-1966** All Carter 2 x 4 sets.
CRS636D.....\$692.00 ea.

Carburetor Kits

Carter Carburetors

- 1961-1967** All 2-4BBL and 4BBL.
Numbers: 3088, 89, 3297, 3578, 79,3633, 35, 65, 3826, 27, 3921, 22, 23, 4053, 54, 55, 56, 59, 60, 61, 4179, 80, 81, 4331, 32, 44, 4453, 3645SB, 3646S, 3925SA (Carter AFB 4BBL). 2 kits needed for 2 x 4 carbs.
CKC617.....\$51.00 ea.

Rochester Carburetors

- 1963** With 401 engines. 2GC 2BBL.
Numbers: 7020046, 047, 048, 049, 7023041, 042, 043, 145, 146.
CKR623.....\$26.00 ea.
- 1963-1966** With 401 engines. 4GC 4BBL.
Numbers: 7023040, 7023143, 7024040, 7025040, 7025140, 7026040.
CKR636.....\$39.50 ea.

1966-1967

- 1966** All:
1967:Early; 430 engines. 4MV 4BBL.
Numbers: 7025240, 242, 7027146, 147, 148, 149, 7027240, 241, 7036240, 242.
CKR667.....\$39.50 ea.

- 1967** Late; With 400, 430 and 455 engines. 4MV BBL.
Numbers: 7027244, 246, 248, 7041304, 305, 306, 307, 308, 309.

- 1968-1970** Numbers: 7028240, 242, 243, 246, 247, 248, 7029240, 241, 242, 243, 7029246, 7040240, 7040243.
CKR670.....\$35.00 ea.

- 1968-1974** With 350 and 455 engines. 4MV 4BBL.
Numbers: 7028244, 245, 7029244, 245, 7040244, 245, 7041245, 7041544, 7042244, 245, 944, 7043244, 245, 246, 7044244, 246, 544, 7044546, 17054900, 901, 902.
CKR684.....\$29.00 ea.

- 1970-1974** 350, 455.
Numbers: 7040142, 143, 148, 444, 446, 7041142, 143, 442, 7042142, 7042143, 842, 7043142, 143, 144, 7044141, 142, 144, 442, 7044444, 17054651, 17055003, 17057350, 351.
CKR704.....\$26.50 ea.

- 1970-1973** With 455 high performance engine. 4MV 4BBL.
Numbers: 7040246, 247, 7041242, 243, 540, 7042240, 242, 243, 940, 7042942, 7043240, 242, 243, 7044240, 241, 252, 540.
CKR702.....\$27.50 ea.

- 1975** With 400 engine. 4MC 4BBL. Number: 7045254.
CKR75.....\$26.50 ea.

- 1975-1976** 455 engine. 4MC, MV 4BBL.
Numbers: 7045240, 541, 548, 17056240, 540.
CKR756.....\$26.50 ea.



BP667

Carter Baffle Plates



BP576

- 1963-1966** All with Carter AFB 4bbl. Stainless steel plate between carb. and intake manifold. This plate is essential for protection against disintegration of aluminum base of carb. It is also necessary for proper idle and smooth running. Recommended is gasket, baffle plate, gasket.
BP576.....\$17.50 ea.

- 1966** All 400, 425 Hi Compression;
1967 All (For Spread bore Carburetors)
BP667.....\$17.50 ea.

Choke Stove Pipe Replacement Kit

- 1963-1967**
All as required.
CSK530.....\$18.25 kit



Choke Stove Pipe Insulator



This modern Aramid Fiber sleeve greatly resembles the original. It is heat resistant up to 650 degrees F. White in color. Also excellent for wrapping vapor locked fuel valves. Sold by the foot. **All years.**
PI300.....\$5.25 ft.

Carburetor Stud

- Made of stainless steel.
1968-1975 All. 350, 400, 430, 455, 4BBL and 4-1/8" long.
CS685.....\$6.00 ea.



Carburetor Bowl Floats



- 1963-1967** Carter AFB 4BBL. Brass. (2 needed per car)
CF577C.....\$34.50 ea.
- 1966-1967** Rochester 4BBL
1966 All: **1967** Early.
CF667R.....\$19.50 ea.
- 1967-1974** Rochester 4BBL
1967 Late;
1968-1974 All.
CF674R.....\$19.50 ea.

Carb. Mounting Gaskets



- 1963-1965** All;
1966 All early models (square bore).
CMG576.....\$4.75 ea.
- 1966-1967** All with Rochester.
CMG667.....\$6.50 ea.
- 1969-1975** All 400, 430, 455 with Rochester 4BBL.
CMG695.....\$4.75 ea.

Gas Filters



- 1963-1966** Gas filter. For cars without air conditioning.
GF636.....\$12.50 ea.



- 1963-1966** For cars with air conditioning.
GF636A.....\$12.50 ea.



- 1967** All; **1975** All.
GF675.....\$3.50 ea.



- 1968-1975** 1968-1974 All;
1975 All 455 engines.
GF682.....\$3.50 ea.



- All years** replacement. Clear in-line gas filter. Great for near gas tank or frame installation. Important for insuring clean fuel to fuel pump.
GF100.....\$4.50 ea.

In Line Gas Filters



- GF140.....For 1/4" ID Hose.....\$9.25 ea.



- GF516.....For 5/16" IDHose.....\$9.25 ea.



- GF516C..For 5/16" ID Hose(clear).\$6.50 ea.

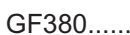

- GF380.....For 3/8" ID Hose.....\$9.25 ea.



Dash Pots



- 1963-1971** Riviera carburetor dash pot.
DP611.....\$29.50 ea.

Choke Pull Offs

- 1968-1974** 430 and 455 engines with 4BBL Rochester. Front.
CPO684.....\$19.50 ea.
- 1971** 455 engines. Rochester 4BBL. Rear.
CPO71.....\$24.75 ea.



Carburetor to Air Cleaner Gaskets



- 1966-1975** All 400, 430, 455 with Rochester 4BBL.
BG5152.....\$3.75 ea.

Ported Vacuum Switches

- 1968-1974** All except 1972 with three port, two terminals.
PVS684.....\$49.50 ea.
- 1972** All three ported with two terminals. (in manifold).
PVS72.....\$49.50 ea.



Rod Clips

- 1963-1966** Carburetor throttle rod clip. 1/4" rod diameter.
RC460.....\$0.75 ea.



Pinch Clamps (Corbin Clamps)

For fuel lines, vacuum lines and PCV hoses

CARS #	YEARS	PRICE
PC380	All3/8" OD hose	\$ 1.00 ea.
PC716	All7/16" OD hose	\$ 1.00 ea.
PC150	All1/2" OD hose	\$ 1.00 ea.
PC916	All9/16" OD hose	\$ 1.00 ea.
PC580	All5/8" OD hose	\$ 1.00 ea.
PC1116	All11/16" OD hose	\$ 1.25 ea.
PC100	All1" OD hose	\$ 1.25 ea.

Intake Manifold Plugs

This plug is often rusted out and sometimes missing. Leakage around this plug causes poor carburetion.

- 1963-1966:** All engines with 4-bbl. carburetor.
MP596.....\$12.75 ea.



Mass Air Flow Sensor

- 1985** Riviera.
MAS85.....\$87.50 ea.

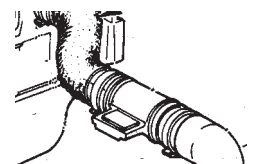

Prom Calibrator (3.670)

- 1985** Riviera with turbo motor.
EP85TR.....\$70.25 ea.

Fuel • Exhaust (Group 3)

Air Filter Elements (3.410)



1963-1964 401 and 425 engines with single carburetors.
AF636\$22.75 ea.

1964-1966 425 engines with 2 4BBL carburetors.
AF646\$32.50 ea.



1965-1966
1965-1966: 401-425 engines;
1967: 430 except dual inlet.
AF657\$15.25 ea.

1967 Riviera G.S. with dual snorkel air cleaner.
AF607\$15.00 ea.

1968; 1970-1975 All.
AF680\$12.25 ea.

1969 All.
AF698\$11.75 ea.

Air Cleaner Parts

1963-1970 Air cleaner wing nut (1/4"-20 thread).
WN530\$1.75 ea.

1971-1980 Air cleaner wing nut (5/16"-18 thread).
WN710\$0.75 ea.



1964-1966 Dual Quad Air Cleaner Nut / Stud
AN646\$22.00 ea.

Air Cleaner Heat Pipe

1970-1974
Air cleaner-exhaust manifold.
Heat pipe.

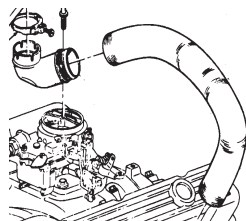

HP704 (silver finish)\$14.50 ea.

HP704B (black finish)\$17.25 ea.

Breather Tubes

(Air Cleaner to Rocker Cover) (1.745)

Breather Tube

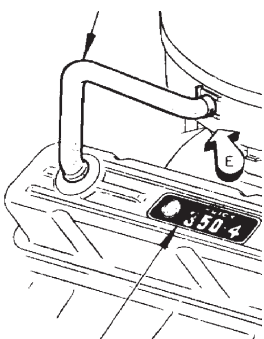

1968-1969
All 350 and 400 4BBL.
VT689\$19.50 ea.



1970-1971 all.
VT704\$19.50 ea.

Crankcase Ventilation Filter

On Side Of Air Cleaner



1968-1972 All.
CVF682\$4.75 ea.

Intake Manifold Gaskets



1963-1966 All.
IMG576\$18.50 set

1967-1971 All.
IMG671\$47.50 ea.

1972-1976 All.
IMG726\$39.50 ea.

Exhaust Parts

Brass Nuts. Tall. All years as required.
3/8-16. Used on manifolds, pipes,
exhaust, trim etc. Solid brass.



N6P\$3.75 pr.



EMG576



EMG676

Exhaust Manifold Gaskets

1963-1966 All.
EMG576\$13.50 pr.

1967-1976 All.
EMG676\$15.00 pr.

Exhaust Manifold French Locks

1963-1966 All as required. Stainless steel!
FL576\$3.50 ea.

1963-1966 All as required. Stainless steel!
FL626\$1.75 ea.



Manifold Anti-Rattle Spring

1963-1969 All.
MS629\$7.75 ea.



1963-1985 Exhaust pipe to manifold
bolt kit. Stainless steel with brass nuts.
FBK340\$9.95 ea.

Fuel Pumps (3.900)

1963-1965 All. Rebuilding service or sold on an exchange with \$50.00 core charge.
FP595RS.....\$89.25 ea.

1963-1965 Replacement fuel pump.
Sold outright no exchange necessary.
FP575.....\$39.75 ea.

1966 All without air conditioning.
FP66.....\$44.50 ea.

1966 All with air conditioning.
FP66A.....\$69.50 ea.

1967-1974 Fuel pump.
1967-1968: All, except those with fuel pump in tank;
1971-1974: All except GS.
FP674.....\$44.25 ea.

1970-1973
1970: GS stage 1;
1971-1973: GS.
FP683.....\$75.00 ea.

1975-1976 All 455 engines.
FP756.....\$39.50 ea.

1977-1984 All 307 engines with 2 fuel lines at pump.
FP774.....\$39.50 ea.



Fuel Pump Rebuilding Kit

1963-1965 All.
FPK575.....\$69.50 ea.



Fuel Pump Block-Off Plates

1963-1976 All as required.
CP300.....\$12.50 ea.



Fuel Pump Hardware Kits

1963-1966 all 401, 425 engines. Correct bolts/washers.
FPH406.....\$2.25 ea.

Fuel Line Clip Kits

1971-1976 Riviera. 3/8" with return line. 16 piece kit.
FLC716R.....\$28.00 ea.

1971-1976 Riviera. 3/8" without return line. 16 piece kit.
FLC716.....\$18.00 ea.

1977-1986 Riviera. 3/8" with return line. 27 piece kit.
FLC776R.....\$32.00 ea.

1977-1986 Riviera. 3/8" without return line. 20 piece kit.
FLC776.....\$25.00 ea.



Gas Tank Sealer/Liner

Alcohol resistant. Quart can.
TS1.....\$34.50 ea.



Gas Tank Straps

1963-1965
TS635R.....\$40.00 ea.

1966-1970
TS660R.....\$40.00 ea.

Gas Tank Strap Cushions

1963-1985 All.
SC350.....\$12.75 pr.

Gas Tanks (shipped oversize)

1963-1965
GT635R.....\$290.00 ea.

1966-1970
GT660R.....\$350.00 ea.

1979-1980 All exc. 350 engine;
1981-1983 All;
1984-1985 All with 307Y.
Includes filler neck. Shipping about \$95.
GT795.....\$197.50 ea.
GS795.....(Strap cushions for above).....\$25.25 pr.



Gas Tank Sending Units

1963-1964 With AC - 2 fuel lines.
SU634RA.....\$79.00 ea.

1963-1964 Without AC - 1 fuel line.
SU634R1.....\$79.00 ea.

1965 With AC - 2 fuel lines.
SU65RA.....\$79.00 ea.

1965 Without AC - 1 fuel line.
SU65R1.....\$79.00 ea.



Gas Tank Parts

1963-1965 Riviera gas tank sending unit gasket.
GG355.....\$3.75 ea.

1963-1965 Riviera fuel gauge screws & washers kit. (5)
GGS355.....\$4.50 kit.

1963-1965 Gas door bumper.
GDB635.....\$5.00 pr.

1963-1970 All. Gas tank bolt kit. Two 3/8-16 x 3" bolts and two lock nuts. Brightly zinc plated.

GB610.....\$5.50 kit

1963-1985 All. Gas tank strap cushions.
SC350.....\$12.75 pr.

1966-1970 Riviera gas tank fuel gauge gasket. (3.112)
GG642.....\$5.00 ea.

1973-1985 Riviera gas tank fuel gauge gasket.
GG671.....\$6.75 ea.

Gas Tank Caps

1963-1965 Riviera gas tank cap. (vented).
GC575.....\$9.50 ea.

1966-1970 Gas tank cap. (non-vented).
GC640.....\$7.50 ea.

1971-1974 All.
GC714.....\$9.75 ea.

1982-1985 Riviera.
GC827.....\$12.75 ea.

1982-1985 Riviera (Locking type w/ key).
GC827L.....\$33.50 ea.



Transmission (Group 4)

Automatic Transmission Kits

Model	Year	Master Overhaul Kit	Banner Kit	Paper, Rubber, Rings & Seals	External Seal-up Kit
Dynaflow.....	1963.....	TOK613.....	TKB613.....	TRK613.....	TSK613
		\$253.00 ea.....	\$207.50 ea.....	\$187.75 ea.....	\$108.50 ea.
TH400.....	1964.....	TOK400F.....	TKB400F.....	TRK400F.....	
		\$124.50 ea.....	\$99.00 ea.....	\$89.50 ea.....	
TH400.....	1965-1998.....	TOK400.....	TKB400.....	TRK400.....	
		\$117.50 ea.....	\$91.50 ea.....	\$89.50 ea.....	

Master Overhaul Kit: Gaskets, Friction (lined) Clutches, Lip Seals, Steel Clutches, "O" Rings, Front Pump Seal Sealing Rings and Extension Housing Seal.

External Seal-up Kit: Stops any external Leaks. Contains Front Pump Seal, Extension Housing Seal, Selector Lever Seal and External Gaskets (including Pan Gasket and Converter Gasket or O-Ring).

Transmission Gaskets and Oil Seals

1961-1963 All. Dynaflow Pan Gasket.	
TPG483.....	\$10.00 ea.
1963 Dynaflow Transmission front pump seal.	
TS483F.....	\$14.00 ea.
1963 all. Rear seal.	
TS616.....	\$10.75 ea.
1964-1976 All. Front seal.	
TS646.....	\$11.50 ea.
1964-1970 All. TH400 rear seal.	
TS640.....	\$12.25 ea.
1964-1972 TH400 pan gasket. 13 bolt.	
TPG645.....	\$9.25 ea.
1971-1976 All. TH400 rear seal.	
TS696.....	\$11.50 ea.

Transmission Filter Change Kits

1964-1966 all; 1967 early type with tube.	
TFK400T.....	\$36.75 ea.
1967 Late;	
1968-1972 all with Turbo 400.	
TFK400.....	\$15.00 ea.

Speedometer Cables

1963-1978 Speedometer cable with casing.	
SC612.....	\$22.75 ea.
1979-1983 All with cruise control. Lower.	
SC793.....	\$18.75 ea.
1982-1983 All with cruise control. Upper.	
SC823.....	\$33.50 ea.
1983 All w/o cruise control;	
1984-1985 All.	
SC835.....	\$36.75 ea.
1963-1985 All. Speedometer cable repair kit.	
SRK360.....	\$16.00 ea.

Banner Kit: Same as Master Kit, but without Steel Clutches.

Paper, Rubber, Rings and Seals: All gaskets, Lipseals, O-Rings, Sealing Rings (Popular Set), Front Pump Seal and Ext. Hsg. Seal.

Speedometer Cable Lubricant

All Years.	
SCL300.....	\$5.00 ea.



Transmission Mounts

1964-1970 TH400 transmission mount.	
TM640.....	(sold outright).....\$38.75 ea.
1971-1974 with TH400.	
TM714.....	(sold outright).....\$14.50 ea.



Transmission Mount Rebuilding Service

We now offer you complete revulcanization of your transmission mounts. Fresh, new rubber will insure safe and smooth running. The mounts listed below are sold on an exchange basis only. If we have your needed mount ready to ship we will charge you an additional core deposit of \$50.00 per item. This charge is fully refundable upon receiving your rebuildable cores. We prefer you send your mounts for rebuilding. Please allow at least 2 weeks for this process.

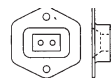

1963 All Dynaflow. Transmission mount. Exchange.	
TM63RS.....	\$142.79 ea.



1964-1972 Vacuum Modulator; All TH400.	
VM642.....	\$35.00 ea.

Neutral Safety Switch

1969-1972 All. Neutral safety switch.	
NSS692.....	\$24.50 ea.



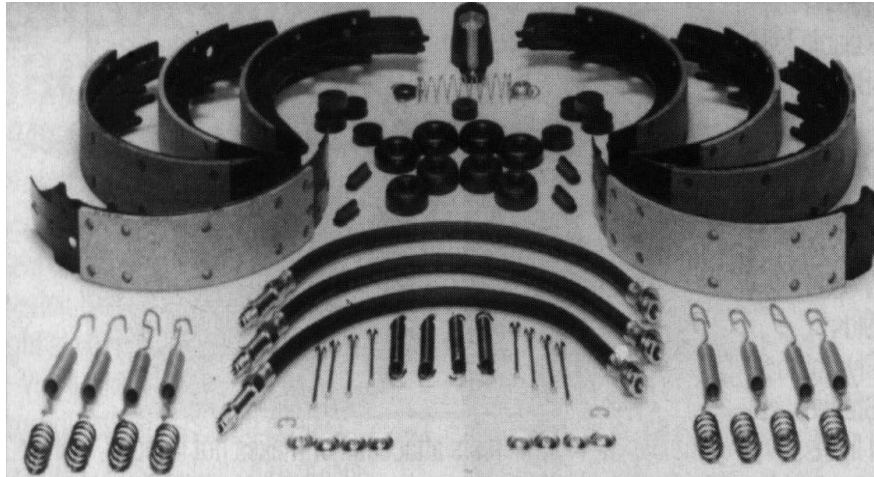

Brake Overhaul Kits

Our complete kits include the following:

- 4 Wheel cylinder kits
- 1 Master cylinder kit. Standard Only
- 4 Brake shoes with linings
- 3 Hydraulic Brake Hoses
- 2 Brake spring hardware kits

1963 All. Does not include master cylinder kit.
BOK63\$157.50 kit

1964-1966 All. Includes power brake master cylinder kit.
BOK646RP\$165.75 kit

1967-1980 All.
BOK670\$179.50 kit



Silicon Brake Fluid

1963-1980 Silicon brake fluid. (one gallon).
SF360.....\$63.00 ea.

Power Brake Rebuilding Service

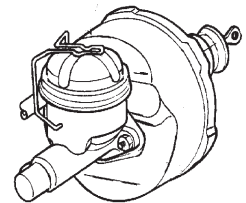

Master Cylinder and Booster with Exchange

1963-1975 Power brake units rebuilt.
PBR610\$279.50 ea.

1963 Brake booster only.
BBR63\$299.50 ea.

Brake Booster Hose Pinch Clamp

1961-1975 All.
PC1116.....\$1.25 ea.

Brake Booster Vacuum Check Valve



(4.955)

1967 all with Bendix power drum brakes;
1968 thru 1985 All.
CV682\$12.75 ea.

Brakes (Group 4)

Master Cylinders

1967-1970 All with power drum brakes.
 MC670M.....Moraine Master Cylinder.....\$97.75 ea.
 MC670B.....Bendix Master Cylinder.....\$97.75 ea.

1967-1970 All with Moraine power disc brakes.
 MC670MD.....\$125.00 ea.

1969 All Bendix power disc brakes.
 MC69B.....\$106.25 ea.



1971-1978 All Moraine power disc brakes;
1979 All exc. rear disc brakes;
1980 All.
 MC680.....\$59.50 ea.

Master Cylinder Rebuilding Kits



1964-1966
1964: All;
1965-1966: With Moraine power brakes.
 MK646\$20.75 ea.

1967-1970 Moraine power drum brakes.
 MK672\$36.50 ea.

1967-1970 All Bendix power drum brakes.
 MK670\$39.50 ea.

1967-1975 All Moraine power disc brakes.
 MK675\$30.50 ea.

Wheel Cylinders

Front

1966-1967
1963-1966: All;
1967: 1st type with 1 1/8" Bore.
 FWC617L.....Left Hand.....\$39.50 ea.
 FWC617R.....Right Hand\$39.50 ea.

1967-1968
1967: Second type with 1 3/16" Bore;
1968: All.
 FWC678L.....Left Hand.....\$49.50 ea. 
 FWC678R.....Right Hand.....\$49.50 ea.

1969-1970 All.
 FWC690L.....Left Hand.....\$47.00 ea.
 FWC690R.....Right Hand\$47.00 ea.

Rear

1963-1966 Rear wheel cylinder.
 State left or right side. 
 RWC500L.....Left Hand.....\$35.00 ea.
 RWC500R.....Right Hand.....\$35.00 ea.

1967-1970 All.
 RWC670L.....Left Hand\$39.50 ea.
 RWC670R.....Right Hand\$39.50 ea.

1971-1976 All. 
 RWC718.....Left & Right Hand.....\$19.75 ea.

Wheel Cylinder Repair Kits

Front



1963-1967
1963-1966: All;
1967: Early 1 1/8".
 FK426\$10.25 ea.

1967-1970 All Moraine power drum brakes - 1 3/16".
 FK670.....\$9.50 ea.

Rear

1963-1966 All.
 RK370\$9.50 ea.
1967-1970 All. Fits either side.
 RK670\$9.50 ea.
1971-1974 All with 11 x 2" drums.
 RK644\$7.50 ea.

Disc Brake Caliper Repair Kits



1967-1969 All front disc brakes.
 (Bendix). For 1 wheel.
 CRK679\$29.50 ea.

1970-1978 All front disc brakes. For 1 wheel.
 CRK696\$16.50 ea.

1979-1997 All front disc brakes. For 1 wheel.
 CRK767\$11.50 ea.

1979-1985 All rear disc brakes. For 1 wheel.
 CRK795R\$19.50 ea.



Master Cylinder Parts



1971-1980 All.
 MCC700.....Cover.....\$9.50 ea.
 MCD700.....Diaphragm.....\$7.50 ea.



www.oldbuickparts.com
908-369-3666

Brake Shoes and Disc Pad Sets (5.017)



Front

- 1963-1970 All. Drum brakes.
BS197\$49.50 set
- 1967-1969 All. Disc brakes. (4 pad set)
DP16\$29.50 set
- 1970-1976 All. Disc brakes.
DP52\$34.50 set
- 1979-1985 All front Disc brakes.
DP797\$45.75 set

Rear

- 1963-1968 All.
BS194\$59.50 set
- 1969-1970 All.
BS340\$59.50 set
- 1971-1974 All. 12" drum. 12' X 2"
BS714\$29.25 set
- 1971-1976 All. 11" drum. 11' X 2"
BS363\$49.50 set

Brake Spring Kits

- 1963-1970 All.
BSK630....(for 2 front wheels)...\$21.50 kit
- BSK630R..(for 2 rear wheels)...\$11.75 kit



Brake Hose Clip



- 1963-1987 All.
BC360.....\$1.25 ea.

Brake Adjusting Screws

- 1963-1978; Fits all front with drums and all rears.
- 1963-1970 All;
- 1977-1978 All.
- BAS636L.....(fits left hand side)\$12.50 ea.
- BAS636R.....(fits right hand side)\$12.50 ea.
- 1979-1981; Fits all front with drums and all rears
- BAS674L.....(fits left hand side)\$10.75 ea.
- BAS674R.....(fits right hand side)\$10.75 ea.



Front Brake Hoses (5.017)



- 1963-1965 All.
FH575\$18.50 ea.
- 1966-1968 All drum brake cars.
FH650\$18.50 ea.
- 1967-1968 Front brake hose. For cars with disc brakes.
FH678\$32.50 ea.
- 1969-1970 ;
1969 All with drum and disc.
1970 All with drum brakes.
FH682\$16.50 ea.
- 1970-1973 All with front disc brakes.
FH703\$19.50 ea.

Rear Brake Hoses



- 1963-1966 Riviera rear brake hose.
RH626\$18.50 ea.
- 1967-1970 All.
RH670\$22.50 ea.
- 1971-1974 All.
RH714\$38.50 ea.

Brake Caliper Set

- 1979-1985 Rivera **Front** Disc Brake Calipers. Re-manufactured.
FBC795R\$89.50 pr.
- 1979-1985 Rivera **Rear** Disc Brake Calipers. Re-manufactured.
RBC795R.....\$89.50 pr.



Brakes (Group 4)

Brake Pedal Pads



1963-1964 Riviera pedal covers. (includes stainless steel "POWER BRAKE" metal strip). Black, Fawn, red, blue, brown, saddle, olive saddle.

PC614.....	Black.....	\$29.50 ea.
PC614F.....	Fawn.....	\$29.50 ea.
PC614U.....	Blue.....	\$29.50 ea.
PC614B.....	Brown.....	\$29.50 ea.
PC614OS.....	Olive Saddle.....	\$29.50 ea.
PC614R.....	Red.....	\$29.50 ea.
PC614S.....	Saddle.....	\$29.50 ea.
PP614.....	(Stainless Strip Only).....	\$6.75 ea.

1961-1964 Riviera pedal covers. (includes stainless steel "PARK" metal strip). Black, fawn, red, blue, brown, saddle, olive saddle.



PC614E.....	Black.....	\$21.50 ea.
PC614EF.....	Fawn.....	\$21.50 ea.
PC614EU.....	Blue.....	\$21.50 ea.
PC614EB.....	Brown.....	\$21.50 ea.
PC614EOS.....	Olive Saddle.....	\$21.50 ea.
PC614ER.....	Red.....	\$21.50 ea.
PC614ES.....	Saddle.....	\$21.50 ea.
PP614E.....	(Stainless Strip Only).....	\$6.75 ea.

Brake Pedal



1965; All.
1967-1970 All.
1971-1974 Will fit but pattern is different.

PC650.....	\$29.50 ea.
------------	-------------



1965-1974 Park brake pedal pad.
PC650E.....\$21.50 ea.

Stop Light Switches (2.447)

1963 All. Stop light switch.
SLS563.....\$10.75 ea.



1964-1975
1964-1970: All;
1971-1975: Except cruise. Stop lamp switch.
SLS645.....\$9.50 ea.

1971-1975 All with cruise control.
SLS715.....\$9.75 ea.

Brake Adjuster Hole Plug

1963-1975 Break adjuster hole plug. (4 per car).
BC340.....\$1.00 ea.

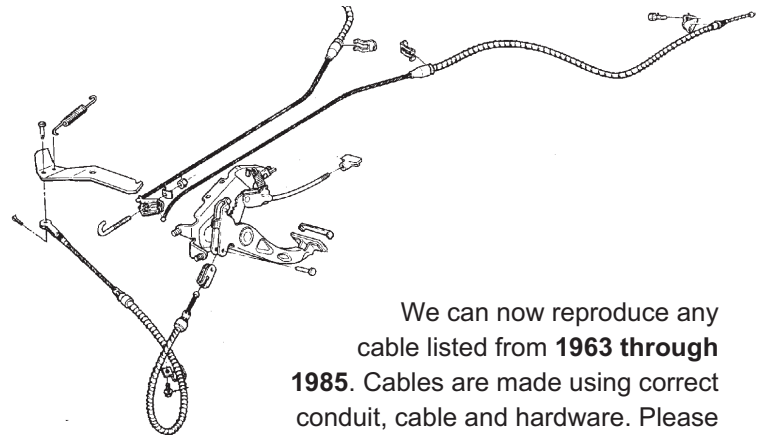

We can now reproduce any cable listed from **1963 through 1985**. Cables are made using correct conduit, cable and hardware. Please note, some cables (*) require that we have your old unit for parts as some hardware items are not available. Some are available with a core charge.

1963-1985 Brake Cables

Year & Model	Front	Center	Rear
1963-1965 All	R1365181\$85.00 ea.	R1370930.....\$59.00 ea.	R1365179\$85.00 ea.
1966-1968 All	R1373385\$85.00 ea.	R1378155.....\$45.00 ea.	R1373917 (2).....\$75.00 ea.
1969	R1387404\$49.50 ea.	R1378155.....\$45.00 ea.	R1373917 (2).....\$75.00 ea.
1970	R1378155.....\$45.00 ea.	R1373917 (2).....\$75.00 ea.
1971-1972	R1236755\$49.50 ea.	R1378155.....\$45.00 ea.	R1236712 (2).....\$39.50 ea.
1973	R1248965\$86.00 ea.	R1378155.....\$45.00 ea.	R1236712 (2).....\$39.50 ea.
1974	R1248965\$86.00 ea.	R1378155.....\$45.00 ea.	R1238232 (2).....\$39.50 ea.
1975	R1248965\$86.00 ea.	R1250616.....\$45.00 ea.	R1238232 (2).....\$39.50 ea.
1979-85 w/rear drums	R25517514.....\$73.00 ea.	BC795RL..RR.....\$58.25 ea.
1979-85 w/rear discs	R25517514.....\$73.00 ea.	BC795RLD..RRD.....\$58.25 ea.

Give your factory wheels that finishing touch!

Note: Buick made several wheels, all appearing nearly identical with one important exception. Some had a 2" center hole, others a 2 1/8" center hole. Our cap units are made up accordingly. Please measure all wheels before ordering,



Chrome Wheel Center Caps & Parts 1964-1965



Chrome wheel cap bezel.
WC645\$34.50 ea.



Plastic emblem.
WP645R\$20.00 ea.



Retainers.
WCR655.....(for 2" hole).....\$6.25 ea.
WCR655B.....(for 2 1/8" hole).....\$6.25 ea.



Wheel cap complete assembly.
WC645R.....(for 2" hole).....\$49.50 ea.
WC645RB.....(for 2 1/8" hole).....\$49.50 ea.

1966-1970

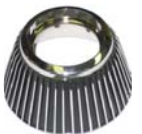

Chrome wheel cap.
WC660\$39.50 ea.



Plastic emblem.
WP660R\$21.50 ea.



Retainers.
WCR650.....(for 2 1/8" hole).....\$7.00 ea.
WCR650S.....(for 2" hole).....\$7.00 ea.



Wheel cap complete assembly.
WC645R.....(for 2" hole).....\$49.50 ea.
WC645RB.....(for 2 1/8" hole).....\$49.50 ea.

1971-1981



Chrome wheel cap bezel.
WC645.....\$29.50 ea.



Plastic emblem.
WP714R\$20.00 ea.



Retainers.
WCR655.....(for 2" hole).....\$6.25 ea.
WCR655B.....(for 2 1/8" hole).....\$6.25 ea.



Wheel cap complete assembly.
WC714R.....(for 2" hole).....\$49.50 ea.
WP714RB.....(for 2 1/8" hole).....\$49.50 ea.

Solid Stainless Steel Wheel Nuts



1965-1972 We have reproduced these hard-to-find nuts to look identical to the originals. Of course they are far superior to the originals as they will never rust and feature the durability and strength of stainless steel. 1/2" - 20.

WN635\$8.50 ea.
WN635S.....(Set of 20)\$150.00 set

Wheel Nuts

(stainless steel capped replacements)



1964-1981 Wheel nuts (1/2-20. Chrome capped).

1964-1975: All;
WN641\$3.00 ea.



1976-1981 7/16-20 wheel nuts.

1976-1981: All.
WN691\$3.25 ea.

1961-1995 Wheel nuts (1/2-20. Standard).

1963-1975: All as required;
1976-1995: LeSabre and Electra all as required.
WN610\$1.75 ea.



Propeller Shaft (Group 5)

Driveshaft Parts

1963 Driveshaft center bearing rubber support (rebuild only).
BS63R\$167.19 ea.

 **1964-1970** Driveshaft center bearing rubber support. Sold outright.
BS619\$92.75 ea.

 **1963-1971** All. Driveshaft center bearing.
DSB611.....\$37.00 ea.

Universal Joints

 **1963-1978** All w/o CV-joint. All as required.
UJ574.....\$22.50 ea.

 **1963-1978** For Cars with CV-Joints where center is recessed for clearance. 1 needed for each cv-joint.
UJ574A.....\$26.25 ea.

Rear Wheel Studs

1963 R.H. SIDE;
1964-1970 L.H. & R.H.
WS630.....\$3.25 ea.



www.oldbuickparts.com
908-369-3666

Constant Velocity Repair Kits



1964 Late models;
1965 All.
CVK615\$59.00 ea.



1966-1968 All.
CVK668\$59.00 ea.

1971-1973 All rear. Without ball.
CVK713\$22.25 ea.

1971-1976 All rear. Includes ball.
CVK716\$39.50 ea.

Brake Drums (5.809)



Cast Iron replacements.
(When replacing aluminum front drums - purchase in pairs.)

Front

1963-1965 Riviera
BD614F\$112.50 ea.

1966-1967 Riviera
BD667\$112.50 ea.

1968-1970 Riviera.
BD680\$113.50 ea.

Rear

1961-1964 Riviera
BD614\$119.00 ea.

1965-1970 Riviera
BD650R\$119.00 ea.

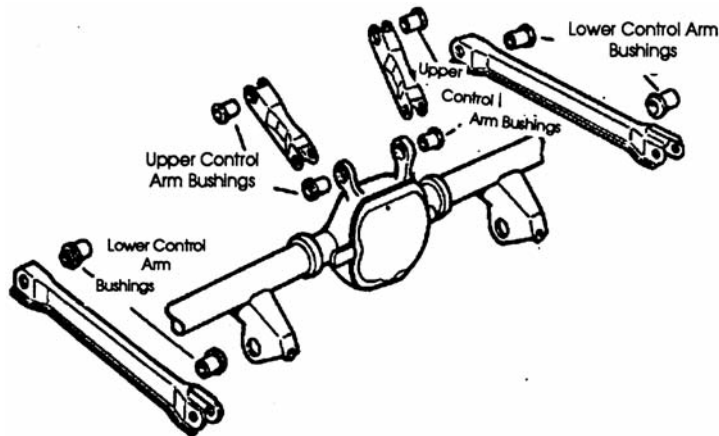

Rear Axle Parts

1963-1970 Rear axle radius "Panhard Bar" rod bushing.
Two per car.
RRB600.....\$49.50 set



Rear Axle Posi-Traction Tag



All Models.
PT635\$5.75 ea.

Rear Axle Posi-Traction Additive

All Years as required. For Posi Rears.
Reduces chatter and noise. Genuine GM.
AL300.....\$11.75 ea.



Rear Axle Control Arm Bushings



1963-1965 All. Three pair needed per car.
RAB635R.....\$144.75 pr.
RAB635RS....(Set of 3 pair).....\$399.75 set
* Note. RAB-652 below can be used for 1963-1965 but are shorter in length.



1966-1970 All. 1 pair needed per control arm.
RAB652\$29.50 pr.
RAB652S....(Set of 4 pair)\$106.50 set

1971-1978 All upper. Two pair needed per car.
RAB716U\$27.50 pr.

1971-1978 All Lower. Two pair needed per car.
RAB716L\$24.50 pr.

Rear Wheel Bearings (5.855)

1963-1967 All.
RWB637\$47.50 ea.
1968-1970 All.
RWB680\$54.50 ea.



1971-1975
1971-1972: All;
1973-1975: With 9 3/8" ring gear.
RWB696\$40.75 ea.

Pinion Seals (5.445)

1963-1970 all
PS630\$20.00 ea.

Rear Axle Gaskets



1963-1965 All. (Carrier).
RCG560\$9.50 ea.



1966-1970 All. (Cover).
RAG660\$9.50 ea.



1971-1975 All. (Cover).
RAG715\$9.50 ea.

Rear Axle Backing Plate Gaskets (5.819)



1963-1967 All.
AG562\$4.50 ea.

Rear Axle Oil Seal (5.822)



1963-1970 All.
OS630.....\$11.00 ea.
1971-1976 all with 8.5" ring gear & 2 7/8" seal.
OS716.....\$11.50 ea.

Suspension and Steering (Group 6)

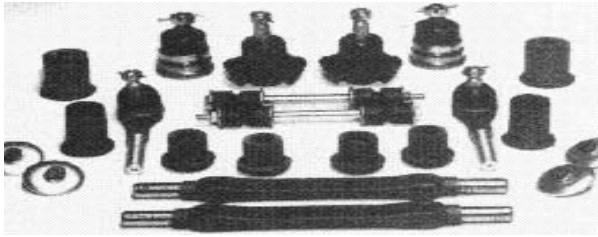

Front End Rebuilding Kits

1963-1986 Kits include;

- 2 Lower Inner Shafts or Bushings
- 2 Upper Inner Shaft Kits or Bushings
- 2 Upper Ball Joints
- 2 Lower Ball Joints
- 2 Outer Tie Rod Ends AR
- 2 Stabilizer Link Kits AR
- Control Arm bumpers AA

1963-1965 All. Includes 4 upper bushings.	
FEK635S.....	\$279.50 kit
1963-1964 All. Includes 2 upper shaft kits.	
FEK634D	\$379.50 kit
1965 All. Includes 2 upper shaft kits.	
FEK65R	\$375.25 kit
1966 All. Includes 4 upper bushings.	
FEK66RS	\$246.50 kit
1966 All. Includes 2 upper shaft kits.	
FEK66RD	\$365.25 kit
1967-1968 All. Includes 4 upper bushings.	
FEK678RS	\$246.50 kit
1967-1968 All. Includes 2 upper shafts.	
FEK678RD	\$365.25 kit
1969-1970 All. Includes 4 upper bushings.	
FEK690R	\$249.00 kit
1969-1970 All. Includes 2 upper shafts.	
FEK690RD	\$365.25 kit
1971-1986 All. Full except FWD.	
FEK716S.....	\$183.25 kit



Power Steering Hoses

1963-1966 Pressure hose.	
SH608P	\$21.50 ea.
1963-1968 All return hose.	
SH638R.....	\$26.75 ea.
1969-1970 All return hose.	
SH690R.....	\$30.25 ea.
1973-1976 All pressure hose.	
SH730P	\$48.00 ea.

Steering Fiber Disc

1963-1975 All. Repair Kit.	
SD570.....	\$22.25 ea.

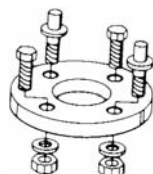

Steering Coupler



1967-1977 All with power steering.	
SC677.....	\$39.50 ea.

Tilt Lever and Knob



1969-1970 Buick Rivera. Correct fluted chrome lever with black knob.	
TL690.....	\$29.00 ea.

Power Steering Pump Kits



1963-1966 All. Complete seal kit.	
SPK596.....	\$34.50 ea.
1967-1985 All. Complete rebuilding kit	
SPK679.....	\$20.00 ea.
1967-1985 All. Complete seal kit.	
SPK673.....	\$20.00 ea.

Power Steering Box Kits



1963 thru 1976 All. Complete seal kit.	
SBK610.....	\$39.50 ea.
1963-1976 All. Complete rebuilding kit.	
SBK606.....	\$82.75 ea.

Power Steering Pump Pulley



1967-1970 All:	
5 3/8" diameter. Oem # 1386935.	
SP670.....	\$59.00 ea.

Pitman Shaft Seal Kit

1963-1985 All.	
PSK577	\$20.00 ea.

Power Steering Pump Reservoir Cap



1963-1966 All.	
RC596	\$59.00 ea.

Steering Column Upper Bearing Kit

1969-1995 All.	
SBK695U.....	\$49.50 ea.



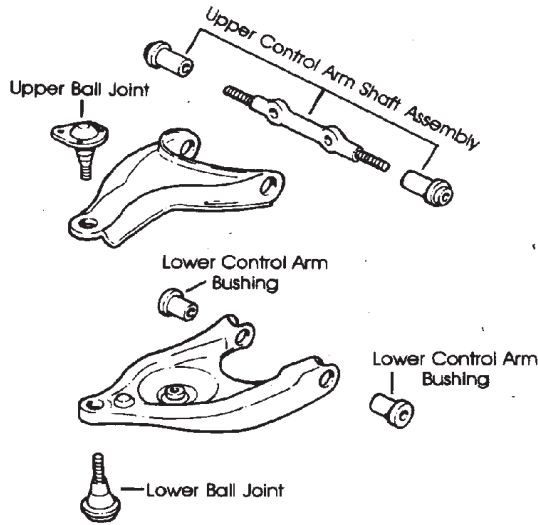



Upper Control Arm (6.169)

- 1963-1970** Upper ball joint.
UBJ630\$59.50 ea.
- 1963-1965** Upper control arm bushings. 2 kits needed/car.
BK545\$39.50 kit
- 1963-1976** Upper control arm bumper.
UB651\$11.75 ea.
- 1963-1964** All. Upper control arm shaft and bushing kit.
UI614\$89.50 ea.
- 1965** All. Upper control arm shaft and bushing kit.
UI65\$115.00 ea.
- 1966-1970** All. Upper control arm shaft and bushing kit.
UI660\$89.50 ea.
- 1966-1970** Front upper control arm bushing.
UAB660\$15.50 ea.
- 1971-1985** All. Upper ball joint.
UBJ717\$24.00 ea.
- 1971-1979** Front upper control arm bushing:
 1971-1973 All. 2 per car.
 1974-1978 All. 4 per car.
 1979 All rear. 2 per car.
UAB719\$6.75 ea.

Steering Wheel Parts

-  **1963-1966** Horn contact for wood wheels.
HC636\$10.75 ea.
-  **1969-1974** Cancelling cam for all tilt wheel applications.
CC694\$14.50 ea.
-  **1969-1974** Horn spring and contact kit. For all standard wheels.
HS666\$9.50 kit
- 1964-1966** Horn ring retainer kit. For cars with walnut wood wheel.
RK646\$30.25 kit

Lower Control Arm (6.168)

- 1963-1970** Riviera lower ball joint.
LBJ630\$59.50 ea.
- 1971-1976** Lower ball joint.
LBJ716\$37.50 ea.
- 1963-1970** Front lower control arm bushings. 2 per car.
LAB610\$49.50 ea.
- 1971-1978** Riviera;
Front lower control arm bushings.
LAB719F\$11.50 ea.
LAB719R\$11.50 ea.
- 1963-1968** Front strut bar bushing kit. (Brake Reaction Rod Kit - For both sides).
BRK638\$29.50 ea.
- 1969-1970** Front strut bar bushing kit. (Brake Reaction Rod Kit - For both sides).
BRK690\$29.50 ea.
- 1961-1965** All. Lower control arm bumper.
LB615\$18.50 ea.
- 1971-1978** All. Lower control arm bumper. Exc. **1973** with radial road handling package.
LB715\$9.75 ea.

Idler Arms

- 1963-1966**
 1963-1965: All;
 1966: With manual steering (assembly).
IA636\$149.50 ea.
- 1966** All with power steering.
IA66\$34.50 ea.
- 1967-1970** All.
IA670\$39.75 ea.
- 1971-1972** All.
IA712\$38.50 ea.
- 1973-1974** All.
IA734\$39.50 ea.





Centerlinks (6.870)

- 1963-1965** All.
CL635R (Rebuilding service)\$292.00 ea.
- 1966** Riviera
CL66R (Exchange service \$200 core)\$349.00 ea.
- 1967-1970** All. Sold outright.
CL670\$217.00 ea.
- 1971-1972** All. Sold outright.
CL712\$187.00 ea.



Grease Fittings

- All models as required. Sold in packs of 10.
-  GF360S (1/4" diameter)\$7.75 pk.
-  GF360B (3/8" diameter)\$8.75 pk.

Suspension and Steering (Group 6)

Front Wheel Bearings and Seals (6.326)



1963-1970 Front wheel grease seal.
GS610\$8.50 ea.



1971-1976 All.
GS716\$4.25 ea.



1963-1975 All. Outer wheel bearing.
OWB616\$11.00 ea.



1963-1975 All.
Inner wheel bearing.
IWB610\$13.75 ea.



1963-1975 Steering fiber disc repair kit.
SD570.....\$22.25 ea.

Wheel Studs



1963-1967 Front.
1963: All right hand.
1964-1967: All L.H. & R.H. front except disc brake.
WS617.....\$3.75 ea.

Stabilizer Bar to Frame Bushings



1963-1966 All.
SB616\$11.75 pr.



1967-1973 With 15/16" bar or smaller.
SB643\$11.75 pr.



1967-1970 With 1" bar or larger.
SB670\$9.50 pr.



1971-1975 With 1" bar or larger.
SB715\$8.50 pr.

Tie Rods and Tie Rod Ends



1963-1965 All. Outer. Two per car.
TE624\$29.75 ea.

1963-1965 All. Inner tie rod. Two per car.
TR635R\$99.50 ea.

1966 Outer tie rod ends. Fits either side.
TE656\$45.75 ea.

1969-1970 Inner tie rod right hand side.
TE690R.....\$98.50 ea.



1966-1970 Inner tie rod.
1966-1968 fits either side;
1969-1970 fits l.h. side.
TR650\$59.50 ea.

1967-1968 Outer right hand side.
TE660\$97.50 ea.



1967-1970 1967-1968 left hand side;
1969-1970 either side outer.
TE650\$30.25 ea.



1971-1976 All. Fits L.H. side outer.
TE716L\$29.50 ea.

1971-1976 All. Fits R.H. side outer.
TE716R.....\$29.50 ea.

Tie Rod Adjusting Sleeve (6.234)

1963-1975 All. Two per car.
AS506\$14.50 ea.

Stabilizer Kits



1963-1965 All. Front stabilizer repair kits.
SK373\$17.00 pr.

1966-1978 All. Front stabilizer repair kits.
SK615\$14.25 pr.

1979-1989 All. Front stabilizer repair kits.
SK863\$14.25 pr.

1963-1975 All. Stabilizer link bushing (8 per car).
SB376\$1.25 ea.

Shock Absorbers (7.345)

CS540....COIL BOOSTER.....\$149.00 per pr.
 AS540.....AIR SHOCKS.....\$169.50 per pr.



Tube type shocks listed below are state of the art gas shocks.

- 1963-1965** Riviera front shock absorbers.
 FS107.....Heavy Duty.....\$79.50 pr.
 FS107G.....(Gas Shocks).....\$93.50 pr.
1963-1965 Riviera rear shock absorbers. Original specs.
 RS135.....Heavy Duty.....\$79.50 pr.
 RS135G.....(Gas Shocks).....\$93.50 pr.
1966-1970 Rear shocks. NOS original Delco pleasurizers.
 RS660.....(Delco Pleasurizers).....\$84.50 pr.
 RS660G.....(Gas Shocks).....\$69.50 pr.
1966-1970 Riviera front shocks. Original specs.
 FS206.....Heavy Duty.....\$79.50 pr.
 FS206G.....(Gas Shocks).....\$93.50 pr.
1966-1970 Rear Air Shock Package. (use you old lwr. bush.)
 RS660A.....\$149.50
1971-1975 Riviera front shocks. Original Specs.
 FS202.....Heavy Duty.....\$79.50 pr.
 FS202G.....(Gas Shocks).....\$93.50 pr.
1971-1975 Riviera Rear Shocks. Original Specs.
 RS175.....Heavy Duty.....\$79.50 pr.
 RS175G.....(State of the art Gas Shocks).....\$69.50 pr.
1967-1970 All. Front shock absorber to upper frame bushings.
 SB376.....\$1.25 ea.
1979-1985 Rear air shock package. Includes lines and valve.
 AS795R.....\$135.00



Chassis Paint

All Years: Satin black paint: This is the correct enamel for frame and engine compartment.

EP2.....\$24.50 qt.
 EP2S.....(12 oz. spray can).....\$14.00 ea.



"Miracle Paint" Tough stuff!

Hirsch brand, works very well as tested by our personnel. Bonds to rust, will not crack chip or peel. Impervious to gasoline, thinner, salt. Can be applied by brush or spray.



- MP300B.....Black\$35.00 qt.
 MP300BG.....Black\$101.00 gal
 MP300S.....Silver\$35.00 qt.
 MP300SG.....Silver\$101.00 gal
 MP300C.....Clear\$35.00 qt.
 MP300CG.....Clear\$101.00 gal
 MP300WG.....White\$101.00 gal

Coil Springs

- 1963-1978** Front coil springs.
 CS350R\$195.00 pr.
1963-1978 Rear coil springs.
 CS350R\$185.00 pr.



Coil Spring Insulators (7.420)

- 1961-1966** Pad, front coil spring insulator, upper. Two per car. 5 1/8" O.D.
 SI381\$15.25 pr.
1965-1975 All. Upper rear.
 SI655\$17.50 pr.
1971-1975 All. Front upper. 5 3/4" O.D.
 SI715.....\$14.25 pr.



Bumper Insulators and Grommets

- 1963-1965** Front bumper bracket to fender outer insulators. Steel insert as original.
 BI635.....\$19.50 pr.
1963-1965 Front bumper grommets.
 BG635\$19.50 pr.

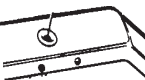

Bumper Bolts, License Plate Area

- 1963-1973** Bumper bolt. 7/16"-16 x 7/8".
 BB643.....\$2.50 ea.
1963-1975 License plate bolt kit. Two bolts and two nuts per kit.
 LB300\$2.50 kit
1963-1981 License plate rubber bumpers.
 LB552.....\$2.75 ea.
1982-1985 License plate rubber bumpers. (Fuel tank door)
 LB820.....\$3.49 ea.
1967-1975 Gas door. (License plate) Bumper.
 GDB635\$5.00 pr.
1963-1975 License plate nuts. Correct round head white nylon fits into 5/16" square hole.
 LN642\$1.25 ea.
1963-1999 License plate nuts. Nylon fits into 3/8" square hole.
 LN600\$1.25 ea.
1963-1999 License plate screw for above nylon nuts.
 S8.....\$0.75 ea.



Bumper Fillers

1979-1985 Riviera bumper fillers made of Fiberglass. This material is not as soft as the original but will last much longer. All pieces come with a manufactures lifetime warranty. Ready to prime and paint.

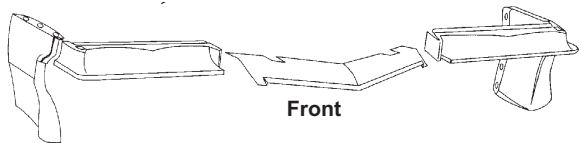

Front - 3 piece set.

BF795F..... (Fiberglass)\$189.50 set

Rear - 4 piece set.

BF795R.....(Fiberglass).....\$199.50 set

Complete Front and Rear Filler Kit

BF795.....\$379.00 kit

1975-1976 Riviera front 3 piece set.

FF756R.....\$299.50 set

1977-1978 Riviera front 2 piece set.

FF778R.....\$99.00 set

1977-1978 Riviera rear 2 piece set.

RF778R.....\$149.50 set



Rear Fender Extensions Fiberglass Replacements

1974-1976 Riviera.

RF746L.....(Left Side)\$139.50 ea.

RF746RR.....(Right Side).....\$139.50 ea.



Bumper Filler Retainer

PR1\$0.50 ea.

PR1B.....Box of 25.....\$9.75 box

Bumper Fillers (Caps)

(7.838)

Rubber trim caps between bumper and fender. Beautifully reproduced to detail the finest of show cars.

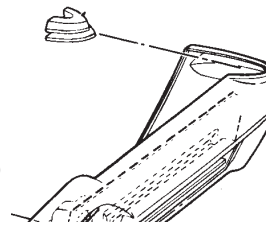

1966-1967 All. Front bumper fillers.

FF667R.....\$25.75 pr.



1966-1967 All. Rear bumper fillers.

RF667R.....\$22.50 pr.



1968-1969 All. Rear bumper fillers.

RF689R.....\$23.75 pr.



1970 All. Front bumper fillers.

FF70R.....\$23.50 pr.



1971-1972 All. Rear bumper fillers.

RF712R.....\$21.50 pr.

Rear Bumper Fillers

1963 thru 1965 All.

BF635.....\$34.50 pr.



GOING TO THE SHOWS?

Free delivery to:

Buick Nationals

GS Nationals

Hershey

CALL WELL IN ADVANCE.



908-369-3666

1963 Hood Emblem



Beautiful reproduction of original. Easy glue-in.
HE63.....\$35.00 ea.



1964-1965 Hood ornament. Stand-up die cast chrome.
HO645\$54.50 ea.



1973-1974 Front Hood Panel Ornament
HO734R.....\$47.50 ea.

Hood Insulation Pre-Cut Gray Fiberglass Ready to Install

- 1963-1965
HI635.....\$33.50 ea.
- 1966-1967
HI667.....\$33.50 ea.
- 1968-1970
HI680.....\$34.50 ea.
- 1971-1974
HI714.....\$33.50 ea.
- 1979-1985
HI795.....\$38.75 ea.
- 1995-1999
HI959.....\$38.75 ea.

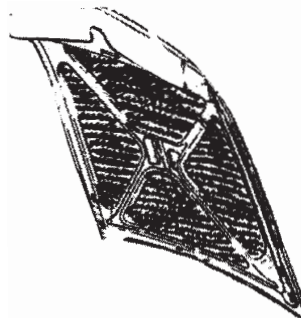

Those not listed. All. Universal gray fiberglass.
48" x 55" x 1"

- HI415.....\$31.00 ea.
- 1978-1990 All as required.
- HIR783.....\$.75 ea.
- HIR78359.....(Pack of 9)\$8.00 ea.

Spray Adhesive for Application of Hood Insulation

SA360.....(20 oz).....\$18.00 ea.



Cars Inc., Recognized Leader in Buick Parts and Service Since 1973

Hood Seal



1968-1969 Front hood to bumper rubber seal.
HS689.....\$52.99 ea.

1963-1975 All.
Front hood rubber bumper. 2 or 3 per car.
HB595.....\$2.75 ea.

Retaining nut for above. All as required
BN650.....\$6.50 ea.

Stainless steel stud for above.
HS585.....\$4.75 ea.

1973-1975 Adjustable front hood bumper with rubber cap (8.024) and stainless steel stud.
HA595.....\$5.75 ea.

1963-1965 All. Hood to fender bumper. Four (4) per car.
HFB635.....\$3.75 ea.

1984-1985 Rivera. Hood bumper goes on the side of the fender where it meets the hood at the rear. 2 needed per car.
HFB827.....\$3.00 ea.

1966-1975 Hood to fender bumper. 5/8" wide. As required. Compare with HFB611.
HFB610.....\$3.25 ea.

1966-1975 Hood to fender bumper. 1-1/4" wide. As required. Compare with HFB610.
HFB611.....\$3.00 ea.

1971-1975 Hood to fender bumper. All rear. 2 per car.
HFB715.....\$3.75 ea.

1971-1975 Hood lace and cowl lace plastic retainer.
LR685\$1.00 ea.

Hood Release Cable

1982-1985 Hood release cable with knob.
HRC825R.....\$99.00 ea.



Hood Opening Rods (8.015)

1979-1985 All.
HOR795.....\$29.75 pr.

Hood • Front Fenders • Rocker Panels (Group 8)

1965 Front Headlamp Bezel



Sometimes called "Cathedral" molding. This molding is die cast from our exclusive tooling, polished and chrome plated to show quality finish. Recesses are painted Argent Silver as original. Inner surfaces are textured as original. Fits either side.

HB65R.....\$249.50 ea.
HB65RS.....Set of 4 correct mounting screws.....\$5.00 set

Fender Patch Panels 18 gauge

1971- 1973 All. Fits lower L.H. side.
FP713L\$96.00 ea.
1971- 1973 All. Fits lower R.H. side.
FP713R.....\$96.00 ea.

Fender Splash Aprons



1963-1965 Front fender to engine compartment.
FA635.....(3 piece set).....\$28.50 set



1966-1970 All. Includes all factory holes required.
FA660R\$18.00 set



1971-1973 All. Includes all factory holes required.
FA713.....\$19.50 set





1963-1966 Fender apron clips.
FSC636.....\$2.25 ea.
FSC636S.....(15 piece set).....\$33.50 set

Make Your Own Fender Splash Aprons

Correct composition rubber material is excellent for duplication using your old aprons as a pattern.



MR4812.....(48" x 12").....\$40.75 ea.
MR4824.....(48" x 24").....\$81.50 ea.
MR4836.....(48" x 36").....\$122.25 ea.
MR4848.....(48" x 48").....\$163.00 ea.
MR4860.....(48" x 60").....\$203.75 ea.

Fender Monograms (8.147)

1963- 1967 All. (Also fits 1967 Hood).
RM637.....\$24.75 ea. 
1965. "Gran Sport" 1st type. 3" x 1/2" (Also fits trunk).
FM65RGS.....\$36.00 ea.
1965. "Gran Sport" 2nd type - 5 3/4".
FM65RGS2.....\$36.00 ea.
1966 "GS" Front fender monogram.
FM66GS.....\$39.50 ea. 
1967- 1968 "GS" Front fender monogram.
FM678GS\$35.50 ea.
1968-1969 "Riviera" Front fender monogram.
Fits either side.



FM689R.....\$69.50 ea.
1970-1974 "GS" fender monogram. (Fits 1967 and 1968 but is a bit thicker and must re-drill) (1973-1974 Paint to match).
FM682G.....\$25.00 ea. 

1971-1974 All. "Riviera"
RM714.....\$33.50 ea. 
1973- 1974 "Stage 1" monogram.
FM704.....\$46.50 ea. 

1979-1985 All.
RM795.....\$25.25 ea. 

Plastic Side Moulding Clip

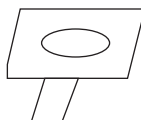

1963-1972 For 3/8" wide retention. Fits all **1963-1965** Fenders, doors and quarter panel side mouldings.
MC600\$1.00 ea.

1963-1970 Rocker Panel Plug.
RP635.....\$4.75 ea. 

Rocker Panel Moulding Clips (8.309)

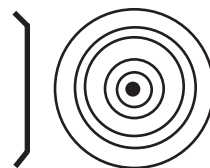

All years and models as required. Will work on any rocker molding that overrides the clip at top and secures with screw at bottom.

MC99\$1.50 ea.
MC99S.....(pack of 25).....\$36.00 ea.



Antenna Base

1963-1965 Antenna Base. Die cast and Chrome plated.

- AB635R.....\$59.50 ea.
- AG635.....gasket for above.....\$8.75 ea.

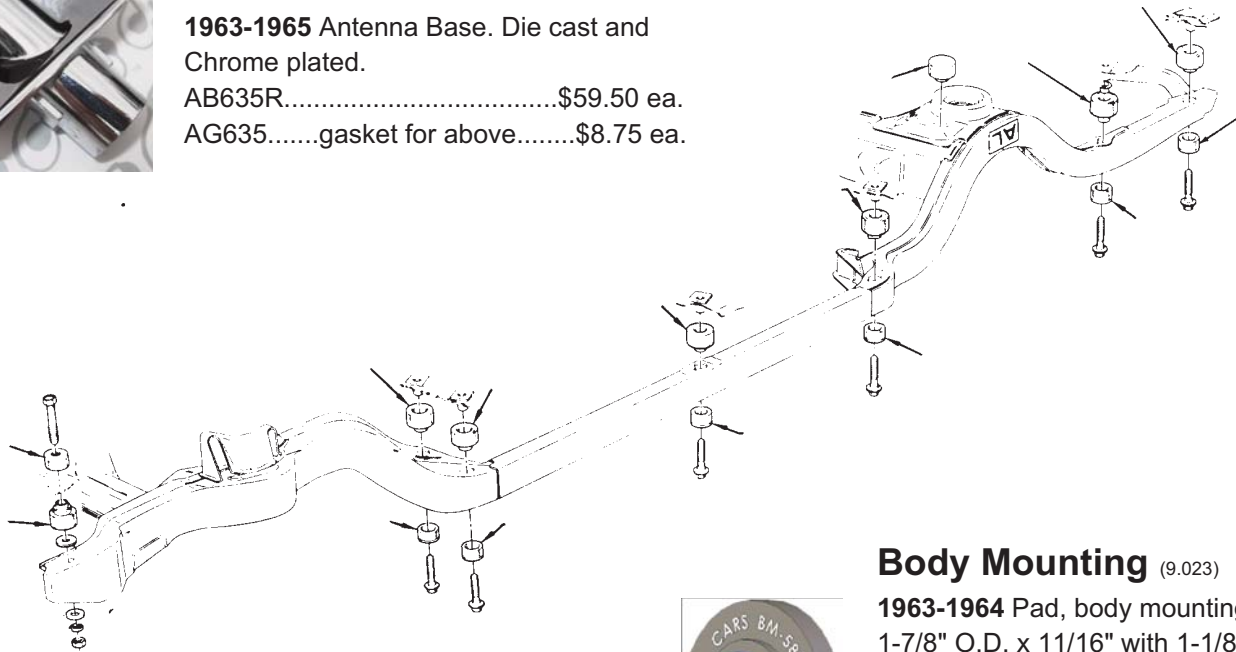

Firewall Insulator Retainer

1963-1990 All as required.

- IR500.....\$1.75 ea.



Firewall Insulator

1963-1965 Riviera. Contour molded as original from strong ABS material. Pre-cut holes. Insulation and rubber draft seals are included as required. Modification may be required for air conditioning. Show quality!

- FI635R.....\$189.50 ea.

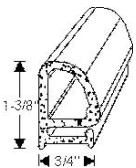

Hood to Cowl Seals (9.127)

1971-1978 LeSabre, Centurion, Electra, Estate Wagon. 72". Includes fasteners.

- CS718.....\$53.99 ea.

Body Mounting (9.023)

1963-1964 Pad, body mounting. 1-7/8" O.D. x 11/16" with 1-1/8" diameter collar, washer and 7/8" O.D. sleeve. Number used varies.

- 1963-1964 All .
- BM584\$11.00 ea.



1963-1965 Insulator, body hold down bolt. 2" O.D. x 7/8" I.D. Number used as required. Some Models.

- BM595\$8.50 ea.



1967-1974 Body mount with metal core. 3/4" ID. 2 1/2" OD. 1 1/8".

- BM644\$10.25 ea.



1963-1965 All. Pad, body mounting. Original type with metal core and spool liner. 10 per car. 2" OD. 3/4" sleeve ID 5/8" high.

- BM635\$9.25 ea.



1967-1974 Core support mount kit. Lower mounts, 2 upper mounts and hardware.

- CSK644\$42.00 ea.



Body to Frame Mounting Pads (Group 9)

Body Mount Bolts

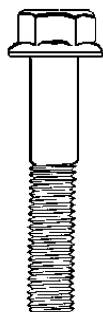

7/16-14 x 2". grade 5
 B1.....\$.75 ea.
 B1B.....(Box of 25).....\$12.75 ea.

7/16-14 x 2 1/2". grade 5
 B2.....\$1.00 ea.
 B2B.....(Box of 25).....\$15.00 ea.

**Don't see your Body Mounts listed?
 If you send your old mounts and bolts,
 we will try and make a complete kit for
 you at a discounted price!**

Universal Body Mounts

These Body mounts are made from original GM molds. They were used in many Buick applications, however, parts books will not identify them by number. Many can be cut, doubled-up, or shaved to fit your needs.



Diameter - 1 11/16"
 Thickness - 11/16"
 Hole Size - 15/16"
 BM2.....\$7.50 ea.



Diameter - 1 15/16"
 Thickness - 3/4"
 Hole Size - 1"
 BM3.....\$9.50 ea.



Diameter - 2 5/8"
 Thickness - 1 "
 Hole Size - 7/8"
 Includes metal insert.
 BM4.....\$9.50 ea.



Diameter - 2"
 Thickness - 1/2 "
 Hole Size - 1/2"
 BM5.....\$9.50 ea.



1961-1964 Grommet for antenna lead on firewall through sheet metal.
 FG599.....\$13.99 ea.



Diameter - 2 1/2"
 Thickness - 3/4 "
 Hole Size - 9/16"
 Includes metal insert.
 BM6.....\$9.50 ea.



Diameter - 2 1/2"
 Thickness - 13/16 "
 Hole Size - none. Solid rubber.
 Insert diameter - 1 5/16"
 BM7.....\$9.50 ea.



Diameter - 1 5/8"
 Thickness - 7/16"
 Hole Size - 3/4"
 BM9.....\$9.50 ea.



Diameter - 2 1/16"
 Thickness - 13/16 "
 Hole Size - none. Solid rubber.
 Insert diameter - 1 5/16"
 BM11.....\$9.50 ea.



Diameter - 2"
 Thickness - 13/16"
 Hole Size - 7/8"
 BM12.....\$9.50 ea.



Diameter - 2 "
 Thickness - 7/8 "
 Hole Size - 9/16"
 Includes metal insert.
 BM13.....\$12.00 ea.

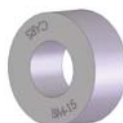

Diameter - 1 3/4"
 Thickness - 1 11/16"
 Hole Size - 7/8"
 BM15.....\$9.50 ea.

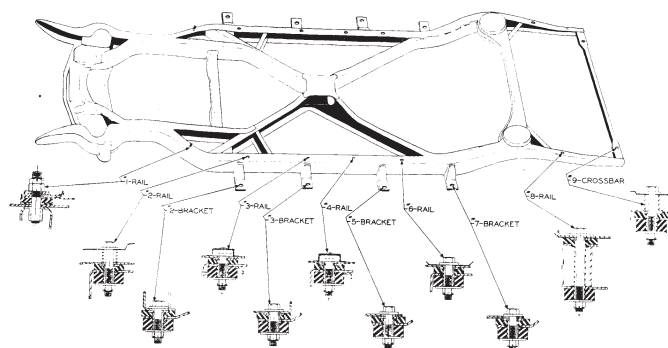



Remanufactured Compressor with Clutch

1963 thru 1977 all 6cyl type as pictured. Delco remanuf.
 AC627 (Single Pulley)\$286.25 ea.
 AC627D (Double Pulley)\$391.00 ea

A.C. Refrigerant for R-12 and 134-a



6 oz. standard can. Includes red dye for leak detection. A drop-in replacement for CFC-12 and HFC-134a. No system evacuation needed. Up to 30% more efficient than CFC-12 and far more efficient than HFC-134a.

ACR360.....\$10.00 ea.

1966-1976 A.C. Blower relay.

1966-1967: All manual;
 1968: All;
 1969-1970: All auto climate control;
 1972: All;

1973-1976: All auto climate control.
 ACR656\$22.25 ea.



1963-1965 A.C. evaporator thermo expansion valve replacement.
 EV635.....\$41.00 ea.



1971-1972 A.C. evaporator thermo expansion valve. (POA).
 EV653.....\$29.50 ea.



1963-1965 Hot gas muffler insulator (sponge rubber).
 MI635.....\$13.50 ea.



MIS635.....Straps for Above.....\$13.50



1963-1974 A.C. compressor clutch bearing.
 ACB585\$41.00 ea.



1971-1977 A.C. compressor thermal limiter Switch.
 TL717\$11.75 ea.



1984-1985 A.C. Compressor relay.
 1984-1985 All V-6;
 1985 All with 307 engine.
 CR840\$11.75 ea.



1979-1985 AC condenser insulator. 4 per car needed.
 RI770\$7.25 ea.



Heater Cores (9.779)

1963-1965 All with A.C. heater core.
 HC638\$129.50 ea.
 1966-1968 All with A.C.
 HC668\$124.50 ea.
 1969-1970 All with A.C.
 HC690R.....\$124.50 ea.
 1971-1978
 1971-1976: All;
 1977-1978: All without A.C.
 HC644\$90.25 ea.
 1979-1985 All.
 HC795R.....\$50.50 ea.



Heater Blower Motor

1963-1976 Riviera.
 HBM646.....\$39.75 ea.



Heater Control Valve

1965-1970
 1965-1966: All;
 1969-1970: All manual A.C.
 HV652.....\$41.00 ea.
 1979-1975 All.
 HV691.....\$29.50 ea.



A/C Vacuum Valve (9 Port)

1979-1985 Riviera.
 ACV820\$39.50 ea.



Heater Valve Insulator

1969-1974 All with air conditioning.
 VI694\$17.00 ea.



1979-1985 Power Antenna Assembly (9.645)

This is a new reproduction antenna, using your old antenna cable connection, antenna nut and antenna tip. A very nice replacement, complete with bracket.

1979-1985 All.
 PA829.....\$165.00 ea.
 AC829...(Replacement cable for above)...\$30.00
 AT829...(Replacement tip for above).....\$4.25



Power Antenna Mast and Tube

1979-1985 All
 AM829\$139.50 ea.



Power Antenna Retaining Nut

1979-1985 All.
 AN827C (Chrome).....\$7.25 ea.
 AN827 (Black)\$8.00 ea.



Antenna Lead

1970-1972 Antenna lead for windshield antennas.
 AL708\$20.00 ea.



Windshield • Front Vent (Group 10)

Windshield Washer Parts



1963-1970 Windshield washer plastic reservoir. "Buick" emblem as original.
WJ630.....\$38.50 ea.

1963-1967
WJC632.....(Cap for above).....\$5.00 ea.

1968-1970
WJC680.....(Cap for above).....\$7.25 ea.

1963-1972 Windshield washer jar cap (90 degree).
WJC632.....\$4.50 ea.

1971-1975 Windshield washer jar.

1971-1972: All;

1975: All.

WJ715.....TOS



**See Hardware
Section Group 17 for
Windshield Clips**

Windshield Washer Pump Repair Kits

1963-1968 All with 90 degree hose fittings.
WRK594.....\$12.25 kit

1963-1968 All with straight hose fittings;

1969-1974 All with depressed wipers.
WRK614.....\$12.25 kit

1963-1967 Washer pump.
WP634.....\$58.00 ea.

1968-1981 All with depressed park (hidden) wipers.
WP683.....\$59.50 ea.

Windshield Wiper Hose

1961-1975 Windshield wiper hose. (7/64").
VH764.....\$1.50 per foot

1961-1975 Windshield wiper hose. (5/32").
VH532.....\$1.50 per foot

1961-1975 Windshield wiper hose. (7/32").
VH732.....\$1.50 per foot

1961-1975 Windshield wiper hose. (1/4").
VH14.....\$1.50 per foot

*****We have a limited supply of **NOS 1/4"** vacuum hose. It features correct outside diameter and "draw" lines for that authentic look.*****

VH14OEM.....\$3.50 ft.

Optikleen Bottles and Caps

1963-1968 all. Bottle assembly. Includes stainless steel bracket and cap.
OB598.....\$36.50 ea.

1963-1968 All. Includes stenciled writing.
OC598.....(Cap Only).....\$6.75 ea.



1963-1968 Optikleen bottle label.

D46.....\$3.75 ea.

1963-1968 Optikleen bottle cap label.

D107.....\$4.00 ea.

Windshield Reveal Moulding Set

1963-1965 3 piece set contains (1) upper and (2) lower mouldings. Beautiful polished stainless steel reproduction. No side pieces are included.

WM635R.....\$189.75 set

Windshield and Rear Glass Seal

Glass setting tape. Provides instant and tight seal.

GS600.....3/8" round x 15' long.....\$12.75 ea.

Butyl dam tape. For use with complete cut-out jobs.

GS601.....3/8" x 1/4" x 15' long.....\$12.75 ea.

Vent Window Weatherstrip

1963-1965 Vent window weatherstrip.

VW635.....\$180.29 pr.

1963-1965 Vent window vertical seal.

VS635R.....\$59.39 pr.

1963-1965 Door glass to vent seal with upper tip.

VS635.....\$82.19 pr.

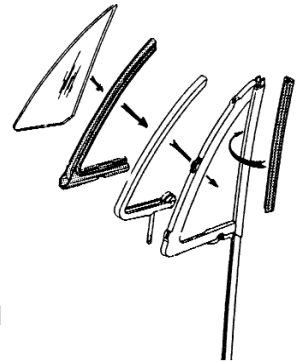

Cowl Seals and Clips

1963-1965 Riviera. Rubber extrusion.

CS635.....\$41.99 ea.

1963-1965 Riviera. Cowl seal clips (12.801)

LR615.....\$2.25 ea.

1968-1970 Cowl seal. 45" extrusion. (9.127)

CS680R.....\$60.59 ea.

1971-1976 Riviera cowl seal.

CS718.....\$32.50 ea.

1968-1971 All. Cowl vent screen "H" retainers. 5 per car.

CSR682.....\$4.00 ea.

CSR682S.....(set of 5).....\$17.00 set.



(Group 10) Door and Roof Rail Weatherstripping



Door Weatherstrip Sets

We are the first company to reproduce the early Riviera door weatherstrips. After years of satisfied customers and show winning cars, our door seals are proven to be #1. They come in pairs, ready to install with correct pins already inserted. They also feature the correct molded ends for proper look and function.

- 1963-1965** Door weatherstrip with molded ends.
DWS635\$69.00 pr.
- 1966-1970** Door weatherstripping with molded ends.
DWS660\$84.50 pr.
- 1971-1973** Riviera door weatherstrip with molded ends.
DWS713\$75.25 pr.
- 1974-1976** Riviera door weatherstrip with molded ends.
DWS746\$71.50 pr.
- 1979-1985** Riviera door weatherstrip with molded ends.
DWS795\$95.00 pr.

Weatherstrip Kits

- 1963-1965 Riviera** Basic Weatherstrip Kit.
Kit Includes: Door weatherstrip with molded ends, roof rail weatherstrip set and trunk weatherstrip.
BRK635.....\$159.00 set
- 1966-1970 Riviera** Basic Weatherstrip Kit.
Kit Includes: Door weatherstrip with molded ends, roof rail weatherstrip set and trunk weatherstrip.
BRK660.....\$163.75 set
- 1971-1973 Riviera** Basic Weatherstrip Kit.
Kit Includes: Door weatherstrip with molded ends, roof rail weatherstrip set and trunk weatherstrip.
BRK713.....\$199.75 set
- 1971-1973 Riviera** Deluxe Weatherstrip Kit.
Kit Includes: Door weatherstrip with molded ends, roof rail weatherstrip set, trunk weatherstrip, lock pillar filler set and rear quarter window vertical seal set.
DRK713\$256.50 set



- 3M** Super Weatherstrip Adhesive. The best we've found
WA360\$13.50 ea.

Roof Rail Weatherstrip Sets

We are the first company to reproduce the early Riviera roof rail weatherstrips. After years of satisfied customers and show winning cars, our seals are proven to be #1. They come in pairs, ready to install with correct hardware included. They also feature the correct molded ends for proper look and function.

- 1963-1965** Side roof rail weatherstrip with molded ends.
RR635\$69.00 pr.
- 1966-1970** Side roof rail weatherstrip with molded ends.
Stops at quarter window
RR660\$81.25 pr.
- 1971-1973** Side roof rail weatherstrip with molded ends.
RR713R.....\$92.75 pr.
- 1974-1976** Side roof rail weatherstrip with molded ends.
RR746R.....\$78.50 pr.
- 1979-1985** Side roof rail weatherstrip with molded ends.
RR795R.....\$89.25 pr.

Window Channel Kits (Sweepers)

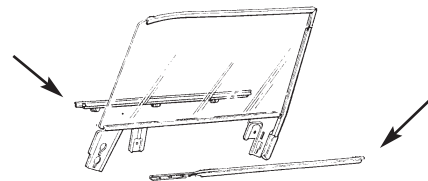

- 1963-1965** Inner and outer window channel sweeper kit.
Made as original. 8 piece kit complete with screws.
WK635\$95.25 kit
- 1966-1967** Inner and outer window channel sweeper kit.
Made as original. 8 piece kit complete with screws.
WK667\$95.75 kit
- 1968-1970** Inner and outer window channel sweeper kit.
Made as original. 8 piece kit complete with screws.
WK680\$89.50 kit
- 1971-1973** Inner and outer window channel sweeper kit.
Made as original. 8 piece kit complete with screws.
WK713\$119.00 kit
- 1979-1985** Hardtops. Inner and outer window channel sweeper kit. 8 piece kit as original, complete with screws.
WK795\$96.00 kit

Exterior Door Parts (Group 10)

Outside Rear View Mirror



1963-1967 Reproduction non-remote mirror fits either side. Identical to the original. Licensed by GM. Includes bracket, gasket and hardware.
 MK617F.....\$97.50 ea.

Bracket and hardware kit. Will also fit original mirrors.
 MB617\$9.75 ea.
 MS617.....bracket screw\$.65 ea.
 AUV1863.....chrome mirror screw\$1.00 ea.

Gasket only. Will also fit original non-remote mirrors.
 MG617F\$9.75 ea.
 Gasket for original remote mirror.
 MG617RC\$9.75 ea.



1968-1969 All. Non-Remote
 Reproduction Right Side Only.
 Includes gasket and hardware.
 MK689RK.....\$149.00 ea.

Mirror Gasket
 MG689R.....\$10.00 ea.

1968-1969 All. Fits LH side non-remote chrome.
 MK689LK.....\$139.00 ea.



Outer Door Skin Retainers 1963-1965 Riviera

We have produced the very hard-to-find and authentically correct nuts and bolts to correctly mount your outer panels.



Special Hex head nut with dome. 8 needed per car.

N1 (1)\$3.75 ea.

N1S(pack of 8)\$25.75 ea.



Special Hex head flange nut. 14 needed per car.

N2\$1.25 ea.

Special T-bolt. 28 needed per car.

S9.....\$3.75 ea.



Complete 58 piece kit.

DPK635.....\$129.50 ea.

Door Bumpers and Parts



1963-1965 Riviera door bumper.
 DB595.....\$2.75 ea.



1966-1970 Riviera door bumper.
 DB660R\$3.25 ea.



1971-1976 All.
 DB500C\$2.75 ea.

Door Lock Pairs With Two (2) Keys

1963-1965 Riviera. With original style keys.

DLS596\$36.00 set



1966-1967 Riviera. With original style keys.

DLS608.....\$39.50 set

1968-1973 Riviera. With original style keys.

DLS683\$24.50 set

Door Handles and Gaskets (10.527)



Includes buttons and springs.
1963-1965 Chrome outside door handles. Includes buttons, springs and gaskets. Show quality!
DH605S\$86.00 set
1966-1970 All. Less buttons.
DH660S\$90.25 set



1971-1973 All. Complete Assembly. Show Quality.
DH713L...Left Side...\$109.00 ea.
DH713R...Right Side...\$109.00 ea.

1963-1970 Gasket set, outside door handle. Die cut rubber construction. 4 piece set for 2 handles. (10.537)

HG590\$10.00 set



1971-1973 All. Fits either side.

HG713\$5.50 ea.



1974-1976 Door handle gasket set. (10.537)

HG716\$11.99 set

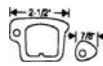

1963-1975 Door lock cylinder gasket.(10.537)

KLG540\$1.25 ea.



Door Handle Pushbutton Kit



Includes 2 each: Pushbuttons, Rubber "O"-Rings, Springs, Retainers and Instructions.

1963-1972 All.

HB642\$18.50 pr.

Door Strikers (10.569)



1971-1976 All.

DS716\$14.00 ea.



1966-1970 All;

1979-1985 All.

DS645\$12.00 ea.









1971-1976 Riviera door striker silencer.

LS716.....\$1.25 ea.

Interior Door Parts (Group 10)

Lock Buttons and Ferrules

-  **1963-1965** All. Chrome door lock buttons.
LB616.....\$4.25 ea.
-  **1968-1970** Chrome door lock buttons.
LB680.....\$4.25 ea.
-  **1968-1970** Black door lock buttons.
LB680B.....\$4.25 ea.
-  **1971-1986** Chrome door lock buttons.
LB710.....\$4.25 ea.
-  **1965** Button ferrule. Transparent plastic
BF617.....\$11.50 pr.
-  **1968-1985** Lock button ferrule. All as required
BF685.....\$2.75 ea.

Power Window Motors

State left hand or right hand. Plug may differ. Hard wire if necessary.

-  **1963-1981** Power window motor.
- WM600LF.....Left Hand Front.....\$127.25 ea.
- WM600RF.....Right Hand Front.....\$127.25 ea.
- WM600LR.....Left Hand Rear.....\$127.25 ea.
- WM600RR.....Right Hand Rear.....\$127.25 ea.
- 1982-1985** Convertibles. Power window motor. (outright).
- WM827.....(Fits Either Side)\$37.50 ea.
- WM827D.....(Genuine Delco).....\$59.50 ea.
- 1982-1985** Convertibles. Rear 1/4 Power window motor.
- WM825L.....(Left Hand).....\$167.75 ea.
- WM825R.....(Right Hand).....\$167.75 ea.



Power Window Switches and Bezels

-  **1964-1970** All "4 in a row" type with bezel.
PWS640.....\$67.50 ea.
-  **1964-1970** All single switch with bezel.
PWS640S.....\$36.50 ea.
-  **1961-1977** All "4 in a row" type with bezel.
PWS717.....\$75.75 ea.
-  **1969-1973** Rivera.
PWS699.....\$109.00 ea.
-  **1971-1977** All single switch with bezel.
PWS717S.....\$34.50 ea.
-  **1974-1976** Rivera.
PWS746.....\$89.00 ea.
-  **1982-1985** Rear quarter window switch.
PWS825R.....\$18.75 ea.
-  **1982-1985** Power window switch in front armrest.
PWS825 (2 Button).....\$51.00 ea.
-  **1982-1985** All. Window switch bezel. Chrome. (1-button).
WSB825S.....\$39.75 ea.

Window Crank Handles

-  **1963-1964** All as required.
WH594\$16.50 ea.

Vent Crank Handles

-  **1963-1964** All as required.
VC594\$16.50 ea.
-  **1963-1975** As required. Door handle retaining clip. (10 per pack).
HRC540\$2.25 ea.

Handle Removal Tool

Remove Window and Door Handle Retaining Clips Without Damaging Door Panels

-  **1963-1977** All.
HT360\$7.75 ea.
-  **1963-1965** Door handle tension spring.
HS395\$1.50 ea.
-  **1963-1973** Door handle washers.
HW552\$3.00 ea.
-  **1968-1974** All with black knob.
WH680B.....\$8.75 ea.
-  **1968-1974** All a clear knob.
WH680C\$8.75 ea.



Inside Door Handles (Paddle Type)

-  **1963-1967** All as arranged, 2 pr. needed for deluxe interiors.
DH607.....\$51.00 pr.

Power Vent Window Gears

-  **1963-1965** Power vent window gears. Bronze.
VG595.....(L&R Hand).....\$97.50 pr.

Power Door Locks and Bezels

-  **1968-1970** All square switch. "LOCK".
DLS680\$69.75 ea.
-  **1971-1977** All square switch. "LOCK".
DLS717\$59.50 ea.
-  **1982-1985** All with switch in armrest.
DLS825R\$49.00 ea.

Door Panel Retainers

-  **1963-1975** All as required.
DPR598.....\$1.00 ea.

Door Sill Plates



(11.175)

1963-1965 Door sill plates with logo.

DS614\$59.50 pr.

1966-1970 All.

DS660\$109.00 pr.

1971-1975 Riviera.

DS715\$89.50 pr.



1963-1985 Glass setting tape.

Sold by the foot.

ST330.....\$0.85 ft.

Air Duct Hose

Sturdy, wire reinforced defroster and air duct made like the original with rubber impregnated cloth covering. Specify inner diameter and length. Sold in foot increments only.



AD150.....	1 1/2"	\$9.00 ft.
AD200.....	2"	\$9.50 ft.
AD250.....	2 1/2"	\$11.75 ft.
AD300.....	3"	\$13.00 ft.
AD350.....	3 1/2"	\$12.25 ft.
AD375.....	3 3/4"	\$13.00 ft.
AD400.....	4"	\$13.00 ft.
AD500.....	5"	\$14.50 ft.
AD538.....	5 3/8"	\$15.50 ft.

Door Hinge Pins and Bushings



1963-1970 Door hinge pin. 11/32" OD x 4".

HP310.....(cut if too long)\$3.00 ea.



1963-1970 Door hinge pin bushing. Two per pin.

HB310\$1.00 ea.



1973-1990 Door hinge pin. All as required.

HP670\$3.00 ea.



1973-1990 Door hinge pin bushings. All as required.

HB820\$1.00 ea.

Window Rollers (10.783)

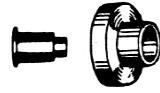

1963-1966 All as required.

Window regulator roller and rivet.

WR576.....\$3.25 ea.

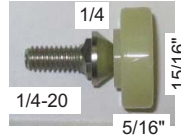

1963-1967 Riviera and as required.

7/8" wide.

WR637.....\$3.75 ea.



1968-1990 all as required. 1 1/16" OD, 1 1/64" ID. nylon.

WR727.....\$2.25 ea.

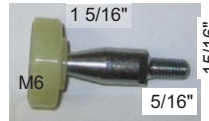

1979-1985 all as required. 5/16 wide.

WR785.....\$6.50 ea.

Drain Hole Seals

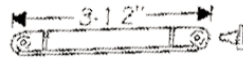

1964-1972 All except 1965. Seal, door bottom drain hole.

HS645.....\$4.00 ea.

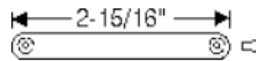

1965 Seal, door bottom drain hole.

HS625.....\$2.25 ea.

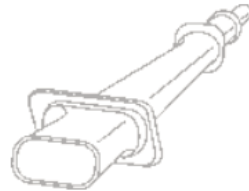

1969-1970 All. Conduit for power window wiring from front door to body. Approx. 17" length extruded rubber tube.

DC650\$68.25 pr.

Interior Parts (Group 10)



Sunshade Rest Grommets

1963-1972 All as required.
SG632\$5.75 pr.



Sunshade Sleeves

1965-1977 All.
SS642\$5.75 pr.



1984-1985 All.
SS829.....TOS



Visor Supports

1966-1970 all. Fits either side.
VS642\$19.75 ea.



1963-1965 Riviera odometer reset knob.
RK425.....\$3.75 ea.



1963-1965 Interior coat hook.
CH396\$12.00 pr.

Interior Rear View Mirror



1963-1965 Riviera 10" Day-nite mirror.
Stainless Steel backed with black twist knob.
IM635.....\$69.50 ea.



1967-1970 All.
10" Polished stainless steel backing,
day/night lever.
IM692.....\$46.00 ea.



1972-1992 as required. 10" black plastic
day-nite.
IM72710.....\$29.50 ea.

1972-1992 as required. 12" black plastic
day-nite.
IM72712.....\$29.50 ea.

Glove Boxes (10.260)



1963 All w/o a.c.
GB63R.....\$28.50 ea.



1963 All with a.c.
GB63RA.....\$28.50 ea.

1964 All black flock.
GB64RB.....\$28.50 ea.

1964 All gray flock.
GB64RG\$28.50 ea.

1965 All black flock.
GB65R.....\$28.50 ea.

1968-1970 All with a.c. glove box.
GB680.....\$26.50 ea.



1971-1973 All.
GB713.....\$27.50 ea.



1963-1965 Glove box door bumpers.
DB635.....\$2.50 pr.

Glove Box Lock (10.266) with Two Original Keys



1966-1967 Riviera.
GBL667.....\$31.25 ea.



1968-1973 Riviera.
GBL683.....\$31.25 ea.



1971-1972 Glove box lock and trunk lock
sets with 2 matching original keys.
LS712.....\$59.75 set



Glove Box Light Switch

1968-1974 Includes light bulb and new
terminal.
GBS644\$14.00 ea.



Rear Ash Trays

1966-1967 All with deluxe arm rests.
AT597\$24.50 ea.



1968-1970 Rear arm rest.
AT687\$35.00 ea.

Rear Quarter Window to Front Window Seals (11.015)

1963-1970 All. Quarter window extrusions. QS644.....\$19.50 pr.

1966-1970 Riviera. Formed with steel. QS645H.....\$24.50 pr.

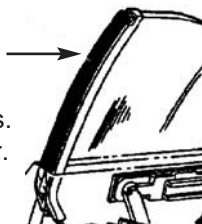

1971-1973 Riviera quarter window seals. Formed. QS713R\$41.50 pr.



1979-1985 Riviera Hardtop quarter window seals. Formed. QS795\$50.50 pr.



LPS635



LPS660



LPS713

Lock Pillar Seals

1963-1965 All. LPS635\$42.50 pr.

1966-1970 All. LPS660\$37.50 pr.

1971-1973 All. LPS713\$37.50 pr.



1963-1965 Interior coat hook. CH396.....\$12.00 pr.



1963-1965 Rear console lens. CL635\$12.00 ea.



1963-1965 Dashboard map lens. ML635.....\$13.50 ea.

Window Channel Liner

1932-1960 Mohair liner with rubber backing. Apply to division bars and channels as req. ML325.....\$11.00 (3) ft.



Dome and Courtesy Lamp Lenses



1963-1968 Courtesy lamp lens (on rear sail panel) round flat lens. Also 63-65 on console. CL618\$6.25 ea.



CB618..(Chrome bezel for above)...\$28.50 ea.



1976-1990 all. Dome lens. DL760\$12.75 ea.



1976-1990 Dome lens bezel. DH760.....\$64.50 ea.



1969 Riviera. Courtesy lens. Round lens with Tri-Shield. CL69R.....\$12.75 ea.



1969 Riviera. Courtesy lens housing. CLH692.....\$17.00 ea.



1971-1973 all. CL713R\$39.50 pr.

Door Jamb Switches

1963-1965 Door jamb switch, 3 prong as original. DJS635\$39.50 ea.



1963-1965 Door lamp switch rubber boot. SB634\$7.00 ea.

1966-1975 Door jamb switch.

1966-1967: All front;
1968-1975: All left front.

DJS665\$8.75 ea.



1968-1970 Front door jamb switch, right hand. DJS642\$6.75 ea.



1971-1973 All. Right;
1974-1975 All. Right and left. DJS716\$12.50 ea.

Sheet Metal (Group 12)

Floorpans and Rocker Panels (12.000)

1963-1965 ALL

Front Toeboard (12.980)

FP635TL.....(LEFT SIDE)	\$94.50 ea.
FP635TR.....(RIGHT SIDE)	\$94.50 ea.

Floor Pan (12.980)

FP635FFL.....(FRONT LEFT)	\$97.50 ea.
FP635FFR.....(FRONT RIGHT)	\$97.50 ea.
FP635RFL.....(REAR LEFT)	\$97.50 ea.
FP635RFR.....(REAR RIGHT)	\$97.50 ea.

Under Seats (12.980)

FP635FSL.....(FRONT LEFT)	\$94.50 ea.
FP635FSR.....(FRONT RIGHT)	\$94.50 ea.
FP635RSL.....(REAR LEFT)	\$111.50 ea.
FP635RSR.....(REAR RIGHT)	\$111.50 ea.

Rocker Panels (12.934)

RP635RL.....(LEFT OUTER PANEL)	\$39.50 ea.
RP635RR.....(RIGHT OUTER PANEL)	\$39.50 ea.
RP635IL.....(LEFT INNER PANEL)	\$43.50 ea.
RP635IR.....(RIGHT INNER PANEL)	\$43.50 ea.

Floor Pan (12.980)

FP660FFL.....(FRONT LEFT)	\$69.00 ea.
FP660FFR.....(FRONT RIGHT)	\$69.00 ea.
FP660RFL.....(REAR LEFT)	\$69.00 ea.
FP660RFR.....(REAR RIGHT)	\$69.00 ea.

1971-1973 ALL

Front Toeboard (12.980)

FP713TL.....(LEFT)	\$97.50 ea.
FP713TR.....(RIGHT)	\$97.50 ea.

Floor Pan (12.980)

FP713FFL.....(FRONT LEFT)	\$95.00 ea.
FP713FFR.....(FRONT RIGHT)	\$95.00 ea.
FP713RFL.....(REAR LEFT)	\$95.00 ea.
FP713RFR.....(REAR RIGHT)	\$95.00 ea.

Under Seats (12.980)

FP713FSL.....(FRONT LEFT)	\$84.50 ea.
FP713FSR.....(FRONT RIGHT)	\$84.50 ea.
FP713RSL.....(REAR LEFT)	\$137.50 ea.
FP713RSR.....(REAR RIGHT)	\$137.50 ea.

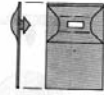

1963-1965 Riviera rocker panel rubber hole plug.
RP635\$4.75 ea.

Trunk Floor Pan

1963-1965 All.

Trunk pan (12.980)
TP635.....\$379.00 ea.



1963-1965 Door Panel Retainers

We have reproduced the correct bolts and nuts that retain the unique removable door panels on your Riviera. These visible hardware items are needed for correct installation and show appearance.



Hex nut with dome. 8 needed per door.
N1\$3.75 ea.
N1S.....(Set of 8 for 1 door)\$25.75 set



Hex nut. 7 needed per door.
N2\$1.25 ea.

T-screw. 14 needed per door.

S9.....\$3.75 ea.



Complete kit for both doors. 58 pieces. A \$171.50 value.

DPK635\$129.50 ea.



Body Plugs



BP120	1/2" Hole Diameter	\$1.75 ea.
BP580	5/8" Hole Diameter	\$1.75 ea.
BP340	3/4" Hole Diameter	\$2.25 ea.
BP780	7/8" Hole Diameter	\$2.25 ea.
BP100	1" Hole Diameter	\$1.75 ea.
BP114	1 1/4" Hole Diameter	\$1.75 ea.
BP112	1 1/2" Hole Diameter	\$2.25 ea.

1963-1964 Rear 1/4 Ornaments



After years of R&D these ornaments or "Horseshoes" are finally completed. They are quality made to be better than Buick produced. The fit and finish are beautiful, chrome plated to perfection and ready to install. Clips are included in the kit. During production in late 1963 or early 1964 Buick changed the pin location of these ornaments. It is believed that the forward end of the ornament was lifting possibly from car wash brushes. The forward pin was located nearer to the end for better support. Our answer was to make pins in both locations. You merely twist the 2 pins not needed with pliers, then dress with a file or dremel tool to level the remaining stud.

1963-1964 All. Set of all 4 pieces for entire car.
RO634.....\$247.00 set

Panel Ornament Clips



1963-1964 Rear 1/4 panel ornament clips for retaining chrome "Horseshoe" ornaments.
MC2\$2.25 ea.
MC2S.....(Set of 36).....\$51.00 ea.



Plastic Side Moulding Clip

1963-1972 For 3/8" wide retention. Fits all **1963-1965** Fenders, doors and quarter panel side mouldings.

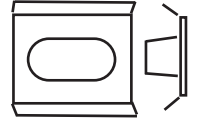

MC600\$1.00 ea.

1963-1965 All. Front fender and rear 1/4 panel mouldings. Wire moulding clip.



Possibly fits other models.

MC5\$0.50 ea.

Side Molding Clip Kit



1963-1965 Contains all necessary and correct plastic clips, wire clips, nuts, etc. To attach all side molding to both sides of car.

36 pieces included.

CK635R.....\$27.75 kit

Roof Panel Emblems



1982-1985 All. Fits either side.

RE825R\$40.75 ea.

Sunroof Weatherstripping

1978 thru 1985 all with electric sliding sunroof.

SW787\$149.50 ea.

Vinyl Roofs - Landau Tops

We can supply vinyl roofs and Landau tops for any Riviera from 1963 thru 1993. Please state year and color. See our website for colors.

VR633R.....Black or White.....\$199.00 ea.

VR633RC.....Colors\$229.00 ea.

Body Moldings • Sheet Metal • Trunk (Group 12)



1963-1975 Trunk weatherstrip.
TW54217\$28.25 ea.



1976-1983 Trunk Weatherstrip. Pinchweld type
TW761\$33.00 ea.

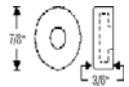

1963-1976 Trunk bumper. Rubber "cap" type.
TB415\$1.75 ea.



1963-1976 Trunk bumper.
Rubber "plug in" type.
TB495\$2.75 ea.

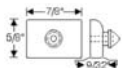

1966-1968 Trunk latch bumper.
TB598\$4.75 ea.



1963-1981 Spare tire hold down bolt.
5/16"-18 x 9 1/2"
STB611\$11.75 ea.



1963-1973 Spare tire hold down wing nut.
TN615\$18.00 ea.



1982-1985 All. Tire/jack retaining nut.
TN820\$12.75 ea.



1963-1980 As required. Trunk lock gasket.
KLG540\$1.25 ea.



1963-1965 Riviera. Trunk lock gasket.
TLG65\$4.75 ea.



1963-1968 Trunk floor pan plug. 3/4" hole.
BP598\$2.25 ea.



1963-1975 As required. Body plug. 1 1/2" hole.
BP355\$3.25 ea.

Trunk Release Button

1979-1985 All as required.
TRB829\$21.50 ea.



Trunk Lock and Keys



1963-1964 All with lock on body. Not for locks in emblems.
TL609B\$19.75 set



1966-1968 All with lock on lid.
TL609\$16.50 set



1971-1972 Glove box lock and trunk lock sets with 2 matching original keys.
LS712\$59.75 set

Trunk Emblems



1965 "Riviera" deck lid monogram. 6 flat spade studs.
DM65R\$39.50 ea.



1965-1967; 1970 "Riviera" deck lid monogram. 4 Round studs.
DM657R\$33.50 ea.



1965 "Gran Sport" trunk emblem. 1st type. 3 1/2" long.
FM65RGS\$36.00 ea

1965 "Gran Sport" trunk emblem. 2nd type. 5 3/4" long. Located on rear panel.
DM65GS2\$39.50 ea.



1966-1967 "By Buick" trunk emblem.
DM667R\$33.50 ea.



1971-1972 "Riviera by Buick" deck lid monogram.
DM712R\$39.50 ea.

1971-1972 Trunk lock bezel.
DB712R\$39.50 ea.



1973-1974 "Riviera Buick" deck lid monogram.
DM734R\$35.00 ea.

Trunk Supports

(gas charged)



1979 thru 1983 All. Fits either side.
TS793R\$12.75 ea.

Hog Rings

For attaching seat covers to frame
HR360Bag of 100\$8.75 ea.



Hog Ring Pliers

For attaching hog rings to seat covers.
HRP360\$30.25 ea.



Convertible Tops

1982-1986 Riviera. Original material pinpoint. Single texture. Glass **NOT** included.
CT826V32\$249.50 ea.

1982-1986 Riviera. Original material pinpoint. Single texture. Glass **NOT** included.
CT826V38\$289.50 ea.

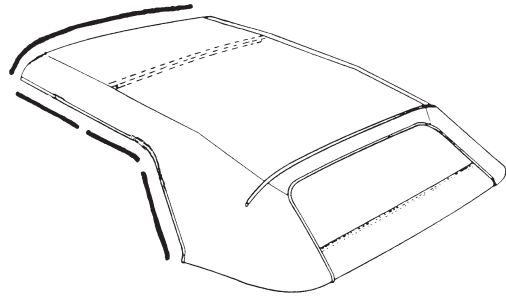

Convertible Top Window

1982-1986 Riviera. Heated glass window. (No zipper).
CTW826\$346.00

Convertible Top Pumps

1982-1985 Convertible top motor pump.
TP645.....\$175.00 ea.



1982-1986 Convertible Top Boots

TB826\$177.25 ea.

1982-85 Convertible Top Cylinders

We now have new convertible top cylinders for all
1982-1985 Riviera.
TC825R\$100.00 ea



Riviera Upholstery Sets (Group 14)

Currently we have kits available for **1963, 1964 and 1965** in vinyl, fabric and leather.

All sets are made with **TOP quality** vinyl, fabric and/or leather with correct grains. All pleats are stitched or "heat sealed" - just like originals. Seat back "inserts" are also made to be identical.

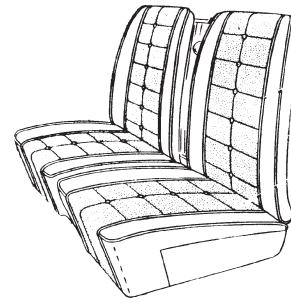

Upholstery Information

Full Sets - consist of both bucket seats and rear seats. We recommend the full set so all colors match. The "FULL SET" does not include the rear side arm rest panel vinyl. This can be ordered separately.

Individual Seat Parts - If you're satisfied with our color match after you see our samples, you may order the piece you need.

Buttons - You will have to use your original buttons. Extra vinyl is supplied for covering them. An acceptable job can be done using a hair drier for heat and a good "super glue".

Vinyl - Only TOP QUALITY - exact grain, many exact original colors. **NO RETURNS due to colors!** We suggest you request samples.

Leather - Leather and vinyl were offered in 1963. We also manufacturer sets for 1964 and 1965 - but no returns. We have matched the original colors and suggest you request samples.

Fabric - Fabric and vinyl were offered from **1963 through 1965**. Most colors are a close match. We suggest you request samples.

Free Color Samples - Call or write stating year, model and color(s) you would like. Samples are sent FREE. Please note: vinyls many not be exact. Some vinyls used with fabrics are not exact matches so suggest you request both samples and decide.

NO RETURN because you did not see a sample.

At this time we do not manufacture door panels, but we can supply vinyl and carpet for them.

Arm Rest Base (14.686)



1963-1964 Riviera. All w/o custom interior.
ARB634.....\$57.50 pr.



1965-1966 Riviera. All w/o custom interior.
ARB656.....\$60.00 pr.



1963-1964 Riviera. All w/o custom interior. Black arm rest pad set. Arm rest base Sold Separately.
AP634B.....\$89.50 pr.



1965-1966 Riviera. All w/ standard interior. Black arm rest pad set. Arm rest base Sold Separately.
AP656B.....\$69.50 pr.



1963-1964 Riviera. All w/o custom interior. Red arm rest pad set. Arm rest base Sold Separately.
AP634R.....\$89.50 pr.



1965-1966 Riviera. All w/ standard interior. Red arm rest pad set. Arm rest base Sold Separately.
AP656R.....\$69.50 pr.



1963-1964 Riviera. All w/o custom interior. Saddle arm rest pad set. Arm rest base Sold Separately.
AP634S.....\$89.50 pr.



1965-1966 Riviera. All w/ standard interior. Saddle arm rest pad set. Arm rest base Sold Separately.
AP656S.....\$69.50 pr.



1963-1964 Riviera. All w/o custom interior. Light Blue arm rest pad set. Arm rest base Sold Separately.
AP634U.....\$89.50 pr.



1965-1966 Riviera. All w/ standard interior. Light Blue arm rest pad set. Arm rest base Sold Separately.
AP656U.....\$69.50 pr.



1963-1964 Riviera. All w/o custom interior. White arm rest pad set. Arm rest base Sold Separately.
AP634W.....\$89.50 pr.



1965-1966 Riviera. All w/ standard interior. White arm rest pad set. Arm rest base Sold Separately.
AP656W.....\$69.50 pr.

(Group 14) **1963 Upholstery**



**Front Bucket
Seat Top**

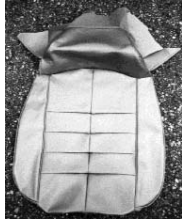

**Front Bucket
Seat Bottom**



**Rear of Front
Bucket Seat**

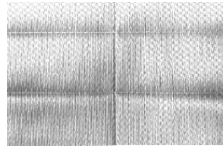

Insert



Rear Seat Top



Rear Seat Bottom

1964 and 1965 (Standard) Upholstery



**Front Bucket
Seat Top**



**Front Bucket
Seat Bottom**



**1965 (Standard)
Rear of Bucket
(Pleats on
"plain" vinyl)**

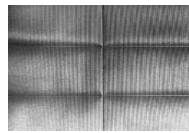

**1964 Rear Insert
(Pleats on fine
vertical lines)**

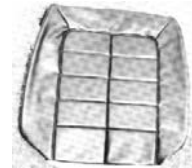

Rear Seat Top

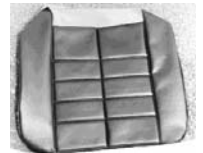

**Rear Seat
Bottom**

1965 "Deluxe" Interior



**Front Bucket
Seat Top**



**Rear of Front Bucket
(Vertical pleats on
"plain" vinyl)**



**Front Bucket Bottom
Carpet Included**



**Ask about Accessory
Rear Arm Rest**

1963-1965 Upholstery (Group 14)

Full Vinyl Sets

Includes both bucket seats and rear seat. All vinyl. Order rear arm rest panels separately. **EXTRA Vinyl Material** is available by the yard. This is the same material used in our seat kits. It comes 52"-54" wide. Sold in FULL yards only. Order by color code. See page 64.

1963 - Vinyl.....SCR3\$649.50 set
1964 - Vinyl.....SCR4\$649.50 set
1965 - Standard - Vinyl.....SCR5\$649.50 set
1965 - Custom - Vinyl.....SCR5C\$989.00 set

VMR81.....\$46.00 per yard x 52"

Order Color By Code See page 64	1963	1964	1965	
			Standard	Custom
Bucket Seat Top Left (drivers) Right	\$129.50 ea. SCR31 SCR32	\$126.50 ea. SCR41 SCR42	\$126.50 ea. SCR51 SCR52	\$215.00 ea. SCR51C SCR52C
Bucket Seat Bottom Left Right	\$89.50 ea. SCR33 SCR34	\$89.50 ea. SCR43 SCR44	\$86.50 ea. SCR53 SCR54	\$117.50 ea. SCR53C SCR54C
Rear Seat Top Left Right	\$86.50 ea. SCR35 SCR36	\$89.50ea. SCR45 SCR46	\$86.50 ea. SCR55 SCR56	\$169.50 ea. SCR55C SCR56C
Rear Seat Bottom Left Right	\$86.50 ea. SCR37 SCR38	\$89.50 ea. SCR47 SCR48	\$88.50 ea. SCR57 SCR58	\$104.00 ea. SCR57C SCR58C
Rear Arm Rest Panel Vinyl Sold as a set of L and R only. Order one get both. Instructions included.	\$84.50 set SCR39	\$84.50 set SCR49	\$84.50 set SCR59	\$84.50 set SCR59C

Full Fabric Sets

Includes both bucket seats and rear seats. Fabric and vinyl. Order rear arm rest panels separately below. **EXTRA Fabric** is available by the yard. It comes 56" wide. Sold in Full yards only. Please order by color code. See page 64.

1963 - Fabric & Vinyl.....SCR109\$849.00 set
1964 - Fabric & Vinyl.....SCR110\$849.00 set
1965 - Fabric & Vinyl.....SCR111\$1289.00 set

VMR137.....\$140.00 per yard x 56"

Order Color By Code See page 64	1963	1964	1965
	Fabric	Fabric	Fabric Custom
Bucket Seat Top Left (drivers) Right	\$189.50 ea. SCR112 SCR113	\$212.00 ea. SCR120 SCR121	\$232.00 ea. SCR128 SCR129
Bucket Seat Bottom Left Right	\$127.50 ea. SCR114 SCR115	\$129.50 ea. SCR122 SCR123	\$145.00 ea. SCR130 SCR131
Rear Seat Top Left Right	\$115.50 ea. SCR116 SCR117	\$119.50 ea. SCR124 SCR125	\$171.50 ea. SCR132 SCR133
Rear Seat Bottom Left Right	\$115.50 ea. SCR118 SCR119	\$119.50 ea. SCR126 SCR127	\$126.00 ea. SCR134 SCR135
Rear Arm Rest Panel Vinyl Sold as a set of L and R only Instructions included.	\$84.50 set SCR39	\$84.50 set SCR49	\$84.50 set SCR59

Full Leather Sets - (14.880)

Includes both bucket seats and rear seat (leather and vinyl). Order rear arm rest panels separately below. Order Color by code listed.

1963.....LMR100.....\$1465.00 set
1964-1965 Standard....LMR100-4....\$1499.00 set
1965 Custom.....LMR297.....\$2030.00 set

Extra Leather - Price per square foot. We need to know the shape you need. For example 1 x 4 or 2 x 2.

LMR136.....\$24.75 sq. ft.

Order Color by Code	1963
Bucket Seat Top Left (drivers) Right	\$253.00 ea. SCR101 SCR102
Bucket Seat Bottom Left Right	\$197.50 ea. SCR103 SCR104
Rear Seat Top Left Right	\$197.50 ea. SCR105 SCR106
Rear Seat Bottom Left Right	\$197.50 ea. SCR107 SCR108
Rear Arm Rest Panel Vinyl Rear Arm Rest Panel Leather	SCR39 \$84.50 set SCR39RL \$187.50 set

1963-1965 Riviera Upholstery Colors and Codes

1963 Vinyl

Codes ()

Light Blue(HLE) Trim #716
 Silver(HVE) Trim #726
 Sandalwood(HZE) Trim #736

1963 Fabric and Vinyl

Fabric Codes ()

Blue(FHE) Trim #717
 Black(FBE) Trim #787
 Sandalwood(FWE) Trim #737
 Gray (not original)(FGE)

Vinyl Codes ()

Blue(HDE)
 Black(HBE)
 Sandalwood(HZE)
 Gray (not original)(HGE)

1963 Leather and Vinyl

Leather Codes ()

Black(LBE) Trim #788
 Red(LRE) Trim #778
 White(LWE) Trim #748
 Saddle(LAE) Trim #798
 Dark Blue(LDE) Trim #718
 Silver(LLE) Trim #728

Vinyl Codes ()

Black(HBE) Trim #788
 Red(HRE) Trim #778
 White(HWE) Trim #748
 Saddle(HAE) Trim #798
 Dark Blue(HYE) Trim #718
 Silver(HVE) Trim #728

1964 Vinyl

Codes ()

Blue(HLE) Trim #601
 Silver(HVE) Trim #602
 Fawn(HFE) Trim #603
 Red(HRE) Trim #607
 Black(HBE) Trim #608 & 628
 Dark Blue(HTE) Trim #621
 White(HWE) Trim #624
 Saddle(HAE) Trim #629

1964 Fabric and Vinyl

Fabric Codes ()

Green(FJE) Trim #610
 Blue(FCE) Trim #611
 Fawn(FFE) Trim #613

1965 Vinyl

Codes ()

Blue(HLL) Trim #601
 White(HWL) Trim #604
 Black(HBL) Trim #608
 Saddle(HAL) Trim #609
 Green(HGL) Trim #620
 Black(HBL) Trim #628
 Saddle(HAL) Trim #629

1965 Fabric and Vinyl

Fabric Codes ()

Green(FGL) Trim #610
 Blue(FHL) Trim #611
 Fawn(FFL) Trim #613
 Black(FBL) Trim #618

Vinyl Codes ()

Green(HJL)
 Blue(HDL)
 Fawn(HFL)
 Black(HBL)

1963-1965 Walnut Veneer Wood Kits (Group 14)

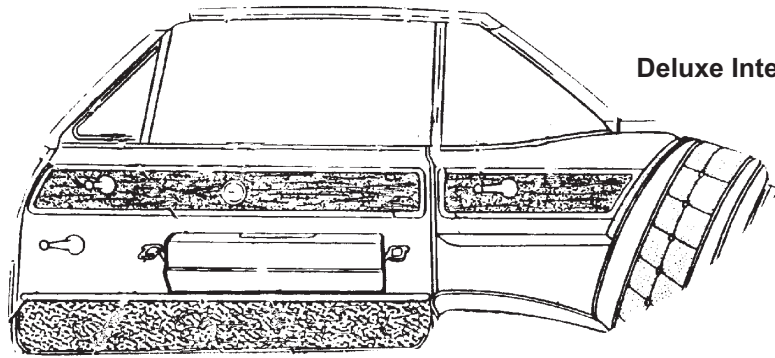

Deluxe Interior Pictured

All of our kits are made with genuine Walnut Veneer just as BUICK used.

We use no stain or coloring of any type so you are assured of seeing only the natural color of the walnut, again as per original. Each piece is sanded and coated three times with clear satin to duplicate the original texture and finish. Adhesive backing is incorporated to give the ease of "peel and stick" installation.

All panels are steel rule die cut so they fit as the originals. Door panels come without holes (set up for power windows). Holes will have to be made for crank window and remote mirror applications. Rear seat panels are included in door kits. 1965 door panels come with black lines already painted. Please state if you have air conditioning or not. Due to variation in original molds, minor trimming with a hobby knife or razor blade may be required.

- 1965 Standard Interior Door Kits.**
 WKD65S....(Horizontal Grain as Original).....\$65.75 pr.
 WKD65SV.....(Vertical Grain).....\$49.50 pr.
1965 Standard Interior Full Kit.
 WK65S.....\$193.00 kit

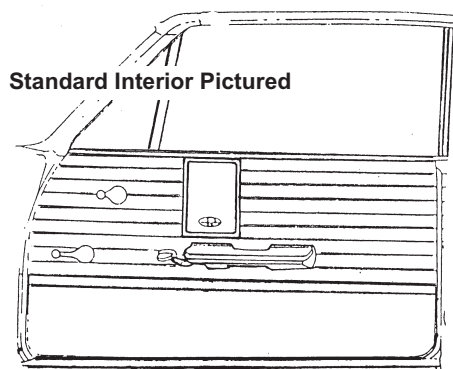

Standard Interior Pictured

Deluxe Wood Panel Kits

Door Panel Kits

- 1963-1964 Riviera wood door panel kit.** Four pieces.
 WKD634\$112.50 set
1965 Riviera wood door panel kit. Four pieces w/ lines.
 WKD65\$179.00 set

Console Kits

- 1964 Riviera w/o a.c. wood console panel kit.** Five pieces.
 WKC64\$137.50 set
1964 Riviera with a.c. wood console panel kit. Five pieces.
 WKC64A\$137.50 set
1965 Riviera All.Wood console panel kit. Four pieces.
 WKC65\$127.50 set

Full Interior Kits

- 1964 Riviera w/o a.c. wood panel kit.** All 9 interior pieces.
 WK64\$240.00 set
1964 Riviera with a.c. wood panel kit. All 9 interior pieces.
 WK64A\$240.00 set.
1965 Riviera wood panel kit. All 8 pieces.
 WK65\$259.00 set

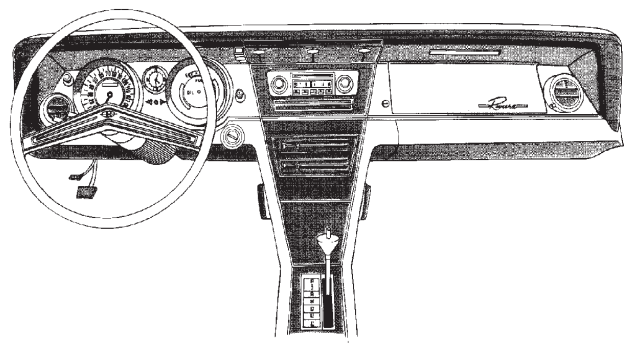

Seat Belts

Quality made aftermarket seat belts come in various colors and styles. Colored belts: add \$3 and code, are custom made and not returnable. Please see our website for colors. 74" recommended for fronts, 60" for rears. Per person.

(Chrome Lift Lever Style)



Lap Belts come standard with authentic style chrome buckle. Black (B), tan (T), rust (R), dark brown (DB), orange (O), glove red (GR), maroon (M), charcoal (C), navy blue (NB), powder blue (PB), turquoise (TQ), ivory (I), white (W), gray (G), silver (S), dark green (DG).

- SB20074B.....(74" Black).....\$39.50 ea.
- SB20060B.....(60" Black).....\$39.50 ea.
- SBH200.....(Hardware Kit).....\$5.25 ea.

Plastic Push Button Style



Lap belts with push-button plastic buckle. Black (B), Taupe (T), Maroon (M), Light Gray (LG), Blue (U). Sizes available are 60" and 74" for the black, light gray and taupe. The blue and maroon are available in 74" only. Colored belts, (add \$3 and code), are custom made and not returnable.

- SB200P74B.....(74" Black).....\$39.50 ea.
- SB200P60B.....(60" Black).....\$39.50 ea.
- SBH200.....(Hardware Kit).....\$5.25 ea.

Metal Push Button Style



Lap belts with push-button metal buckle. Black (B), Taupe (T), Gray (G), Colored belts, (add \$3 and code), are custom made and not returnable.

- SB200M74B.....(74" Black).....\$39.50 ea.
- SB200M60B.....(60" Black).....\$39.50 ea.
- SBH200.....(Hardware Kit).....\$5.25 ea.

Seat Belt Hardware Kit



- SBH200\$5.25 ea.

Seat Belt Buckle Emblems



- Old Style Buick Coat of Arms. Fits well on our Lift Lever Seat Belts.
- TBE550.....\$7.50 ea.



- GM Mark of Excellence. Fits well on our Lift Lever Seat Belts.
- D55\$3.75 ea.



- GM Mark of Excellence. Embossed. Fits well on our Lift Lever Seat Belts.
- D55E.....\$6.50 ea.



- 1967-1972 GM Mark of Excellence. Seat belt emblem.
- D55E.....\$6.50 ea.

Bucket Seat Hinge Cap

- 1963-1965 Riviera
- HC625.....\$12.00 ea.



1970-1972 Bucket Seat Back Release

- Fits 1970-1972 Riviera. Bright chrome bezel and button. Retainer is not included.
- SB692.....\$18.00 ea.



Riviera Headliners 14.640

We have a few of the exact original grain and colors and hope to add more. Please send a small piece of your headliner and we will do our best to match it. If we do not have the exact grain we will send you a sample of the closest color we have.

OUR headliners come with extra material to cover your visors.

1963-1965

Original Grain Material \$199.50

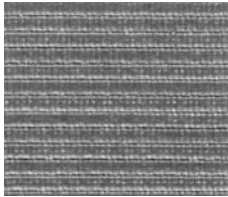

Black	HL635
White	HL635W
Dark Red	HL635R
Dark Blue	HL635U
Silver	HL635S
Beige	HL635G
Saddle (sprayed)	HL635SAD

Other colors - send your samples

Non-Original Grain \$159.50

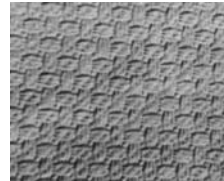

Basketweave

HLB635.....Black.....	\$159.50
HLB635W.....White.....	\$159.50
HLB635DB.....Dark Blue...	\$159.50
HLB635LB.....Light Blue...	\$159.50

Non-Original Fineweave Grain \$210.25

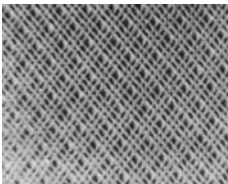

HLF635.....Black.....	\$210.25 ea.
HLF635W.....White.....	\$210.25 ea.
HLF635T.....Tan.....	\$210.25 ea.
HLF635R.....Red.....	\$210.25 ea.
HLF635LB.....Light Blue.....	\$210.25 ea.
HLF635BB.....Bright Blue.....	\$210.25 ea.
HLF635B.....Beige.....	\$210.25 ea.

1966-1976

Vinyl Headliner \$259.75

Available in several textures & many colors. Please specify in order notes at checkout.

HL636.....	\$259.75
------------	----------

Sunvisor Recovering Service

1963-1965 All.

Please carefully remove your material before sending the sunvisors to us. The price includes material and new chrome ends installed. We cannot recover badly warped visors. Recovering service.

SR635	\$72.25 ea.
-------------	-------------

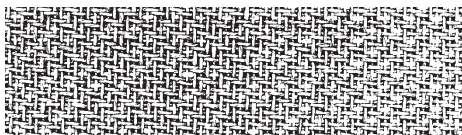

Package Shelf Material

All models as required. Woven straw material duplicates the texture and appearance of the original. Comes in 18" x 64" roll. It can be applied to hardboard with spray adhesive (SA360), then trimmed to fit. Paint to match. All models as required.

PS300	\$59.50 ea.
-------------	-------------

1963-1965 Rear Sail Panels

Ready to install, already covered with headlining material.

SP635.....	\$125.00 pr.
------------	--------------

Bare Panels - you cover yourself.

SP635B	\$99.50 pr.
--------------	-------------

Sound Deadening Material

Heavy, Black, Tar type material.

SD300.....39" x 72".....	\$44.75 ea.
--------------------------	-------------

Waffle pattern, Dark Brown, more paper type.

SD301.....27" x 36".....	\$27.50 ea.
--------------------------	-------------

Closed-cell foam. Adhesive-backed. Form-fitting. Light and soft. Nice underpadding.

SD302.....42" x 72".....	\$37.50 ea.
--------------------------	-------------

(15.286) **1963-1975** (15.306)

Custom Form Molded Carpet Sets



Our carpets are Form Press Molded to manufacturers specifications for correct fit and easy installation. All sets include matching vinyl heel pad on drivers side, molded foot wells and jute underpadding. Our carpets are made from Dorsett roll goods, the highest quality automotive carpet available today.

When ordering, please specify color number, year, model and style of car. Colors listed are "names" only and do not imply any exact shade, color or trim code that may have been originally offered. FREE samples are available by sending S.A.S.E. We strongly suggest that you receive a sample before you purchase any carpet. You may also visit our website www.oldbuickparts.com and see group 15 for a color sampling of our carpets. Sorry, no returns on custom made items.

**500 Series 80/20
Nylon Loop
\$209.50**

COLORS AVAILABLE:

- C501 - Black
- C506 - GM Blue
- C508 - Turquoise
- C509 - Olive Green
- C510 - Brown
- C511 - Light Saddle
- C512 - Sky Blue
- C515 - Red
- C521 - Medium Saddle
- C522 - Lt. Blue
- C523 - Gold
- C525 - Maroon
- C527 - Gray
- C540 - Midnight Blue
- C543 - Ford Tan
- C544 - Emberglow
- C546 - Lt. Oxblood
- C557 - Gun Metal Gray
- C559 - Ivy Gold
- C565 - Red
- C570 - Gold
- C571 - Fawn

Jute Padding 36" x 72".

For under carpet padding and sound control.

JP360.....14.50 ea.

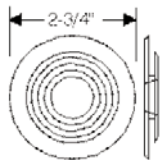

Grommet for dimmer Switch on carpet floor. 1" hole.

SG360.....\$9.50 ea.

Carpet for Door Panel Bottoms

All years and models. 8" wide. State carpet number.

DPC610\$59.50 pr.

Carpet By the Yard - add "Y"

800 Series 100% Nylon

CUT PILE \$209.50

COLORS AVAILABLE:

- C801 - Black
- C8019 - Medium Opal
- C802 - Blue
- C807 - Dark Gray
- C8075 - Medium Gray
- C8078 - Medium Quartz
- C810 - Brown
- C812 - Royal Blue
- C815 - Dark Red
- C8170 - Lapis Blue
- C818 - Ocean Blue
- C820 - Saddle
- C825 - Maroon
- C826 - Titanium
- C8275 - Agate
- C830 - Buckskin
- C832 - Dark Sapphire
- C8335 - Med. Neutral
- C834 - Sand
- C835 - Firethorn
- C840 - Navy Blue
- C8405 - Dark Navy
- C849 - Jade Green
- C851 - Biscuit
- C853 - Silver
- C854 - Caramel
- C865 - Mocha
- C8655 - Med. Mocha
- C868 - Med. Dark Gray
- C871 - Taupe
- C875 - Oxblood
- C8835 - Med. Beige
- C8935 - Adriatic Blue
- C8945 - Dk. Graphite
- C897 - Charcoal



**Essex Premium
Plush Pile
\$249.50**

COLORS AVAILABLE:

- C1001 - Black
- C1024 - Med. Dark Graphite
- C1033 - Blue
- C1038 - Charcoal
- C1054 - Caramel
- C1060 - Brown
- C1062 - Med. Dark Flint
- C1067 - Dark Taupe
- C1076 - Prairie Tan
- C1079 - Dark Slate



Kick Panels

Heavy duty "waterproof" cardboard panels.

- 1963-1964 Kick Panels**
- KP634.....\$29.75 pr.
- 1965 Kick Panels**
- KP65.....\$29.75 pr.

Trunk Mats (15.294)



1963-1975 all.

- TM615.....**Black** with white logo.....\$139.00 ea.
- TM615S.....**Saddle** with white logo.....\$139.00 ea.

1963-1976 Accessory Floor Mats

Now Available in Saddle Brown and Black

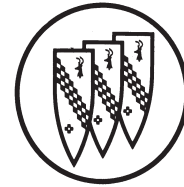

1963-1976 Floor Mats. Black with White Logo

FM615.....Front and Rear.....\$229.50 set

1963-1976 Floor Mats. Saddle with White Logo

FM615S.....Front and Rear.....\$249.50 set

1963-1976 Floor Mats. Red with White Logo

FM615R.....Front and Rear.....\$239.50 set

1963-1976 Floor Mats. Blue with White Logo

FM615U.....Front and Rear.....\$239.50 set

1963-1976 Floor Mats. Green with White Logo

FM615G.....Front and Rear.....\$239.50 set

1963-1976 Floor Mats. Brown with White Logo

FM615N.....Front and Rear.....\$239.50 set

Floor Mat Set - Universal 4 Piece Set

These are a high quality carpeted floor mat set. Made of high quality carpet. Available in Cutpile or Loop. Finished With A Seamed Binding. A complete set of 4 mats. Front Mat Measures 25-3/4" High by 16-3/4" Wide. Available in Many Colors. Quality Nibbed Backing Prevents Mat Creep. These Mats Stay In Place!

Select Carpet Type And Color Below

FM300.....\$89.50 yd.

NYLON LOOP

Black	Medium Blue
Red	Medium Saddle
Aqua	Maroon
Ford Blue	Fawn
Dark Blue	Gold
Dark Green	Genmetal Gray

NYLON CUT PILE

Black	Graphite
Dark Gray	Desert Tan
Red	Flame Red
Oxblood	Medium Gray
Sandstone	



**Rear Window Package Shelf
(Shipped oversized)**

- 1963-1965** Original style Madrid Grain board, available in colors. State color and with or without defogger holes.
 PS635B.....(Black w/o holes)\$51.00 ea.
 PS635BH.....(Black w/ holes).....\$51.00 ea.
1971-1973 Riviera.
 PS713\$56.00 ea.

Package Shelf Jute Insulation

- 1963-1965** Riviera.
 PJ635\$15.00 ea.
1971-1973 Riviera.
 PJ713\$20.00 ea.

Sound Deadening Material (15.492)

- All Years.** 39" x 72"
 SD300\$44.75 ea.

Firewall Insulators (15.280)

- 1963 thru 1965** All.
 FI635R\$189.50 ea.

Trunk Panel Cardboard Kits

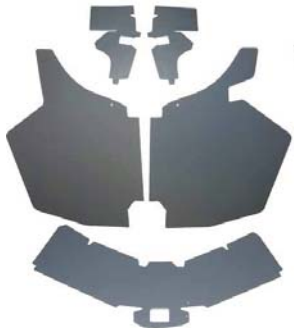

- 1963-1965**
 For cars without remote trunk release.
 5 piece gray.
 TPK635\$78.25 ea.



- 1963-1965**
 For cars with remote trunk release.
 5 piece gray.
 TPK635R.....\$75.25 ea.



- 1966-1967** All. 4 piece. Black.
 TPK667R.....\$70.25 ea



- 1968-1970** All. 2 piece. Black.
 TPK680R.....\$38.50 ea.

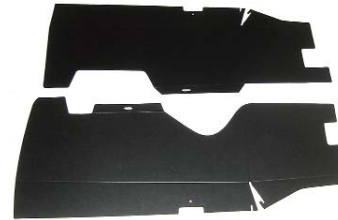

- 1971-1972** All. 4 piece. Black.
 TPK712R.....\$70.25 ea.



- 1973** All. 4 piece. Black.
 TPK73R.....\$70.25 ea.



- 1974-1976** All. 4 piece. Black.
 TPK746R.....\$77.25 ea.

Trunk Linings • Trunk Panels (Group 15)

Trunk Lining Material

1963-1966 Tan weave foam back trunk material. Foam backed. 3 yards needed. 4 1/2 yards with spare tire cover. 48" wide.

TM616.....\$TOS yd.

1966-2010 Dark gray trunk material. 54" wide.

TM660\$19.75 yd

1966-2010 Black trunk material. 54" wide.

TM660B.....\$19.75 yd

1971-1973 6 pc. trunk lining kit. Die cut high quality black carpet.

TLK713.....\$119.75 kit

Spare Tire Covers - 1963 thru 1965

Fully molded, sewn and complete as original (15.100)

1963 Early Models with full spare tire cover.

STC63\$inquire ea.

1963-1965

1963: Late models;

1964 -1965: All. Half cover style.

STC635.....\$51.00 ea.

Trunk Cover Kit

1963-1965 Riviera

Trunk Insulation Pre-Cut Kit With ABS Cover.

Ready to install.

This is a new product that includes die-cut insulation and a smooth ABS cover to completely cover the underside of the trunk. Fastened with pins in holes in the lid. Kit

Includes:

- Trunk Insulation
- ABS Cover
- Spray Adhesive & Metal Tape
- Installation Instructions

This kit will add an additional level of noise and sound dampening.

A Similar kit is also available for the hood.

Available Options:

TC635..... \$116.50 ea.

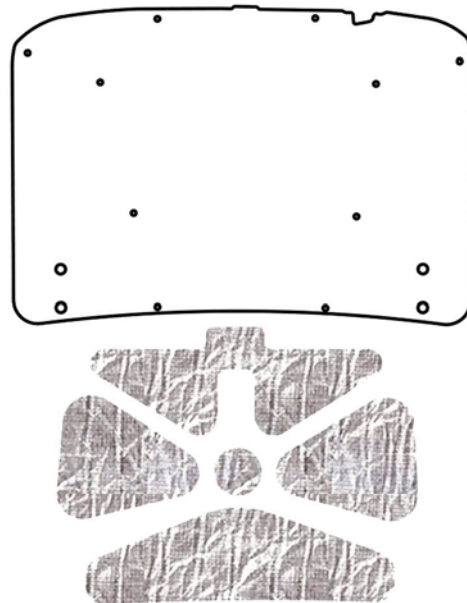

SHOP MANUALS: A Shop Manual is *ESSENTIAL*. This should be your very first purchase after buying your car. These fully illustrated books were originally developed by **BUICK** for trained **BUICK** mechanics. They offer in detail, description and analysis as well as maintenance and step by step overhaul procedures. All of our Shop Manuals are *Full Size* as originals and feature the clearest print and pictures available in a "xerox" type copy. The covers are "in color" and protected by a heavy clear plastic to keep them clean. As an additional feature, each manual is spiral bound in plastic for long lasting use.

CD-ROM: Most shop manuals on CD-ROM contain Buick production facts and figures, shop/service manual, body service manual, parts book, all applicable supplements, sales literature, product information and trivia. This is a complete package.

FISHER BODY MANUALS: These books are "Shop Manuals" for the Body of the car. Topics include Doors, Panels, Weatherstripping, Glass, Glass Channels and all interior.

OWNERS MANUALS: Originally placed in the glove compartment of each car. They contain a wealth of information on awareness, instruction and maintenance of your newly purchased car.

CHASSIS AND BODY PARTS BOOKS: These books were sent to **BUICK** dealership for their Parts Department Staff to recognize and identify parts. The illustrations within, enable you to find the "group" and "part number" of each part - then identify.

All items listed below are quality copied from genuine Buick originals. They are provided as informative tools for restoration purposes.

Shop Manuals		Fisher	Owners	Chassis & Body
Paper	CD-ROM	Manuals	Manuals	Parts Books
1963 ALL.....SM63.....\$49.50	SM63CD.....\$49.75	BM63.....\$35.00		PB63.....\$49.50
1964 ALL.....SM64.....\$49.50	SM64CD.....\$49.75	BM64.....\$35.00	OM64R....\$14.50	PB64.....\$49.50
1965 ALL.....SM65.....\$49.50	SM65CD.....\$49.75	BM65.....\$35.00	OM65R....\$14.50	PB65.....\$49.50
1966 ALL.....SM66.....\$62.50	SM66CD.....\$49.75	BM66.....\$35.00	OM66R....\$14.50	PB40.....\$89.50
1967 ALL.....SM67.....\$62.50	SM67CD.....\$49.75	BM67.....\$35.00	OM67R....\$14.50	PB67.....\$57.50
1968 ALL.....SM68.....\$62.50	SM68CD.....\$49.75	BM68.....\$35.00	OM68R....\$14.50	PB68.....\$57.50
1969 ALL.....SM69.....\$62.50	SM69CD.....\$49.75	BM69.....\$35.00	OM69R....\$14.50	PB69.....\$57.50
1970 ALL.....SM70.....\$62.50	SM70CD.....\$49.75	BM70.....\$35.00	OM70R....\$14.50	PB40.....\$89.50
1971 ALL.....SM71.....\$62.50	SM71CD.....\$49.75	BM71.....\$35.00	OM71R....\$16.50	PB40.....\$89.50
1972 ALL.....SM72.....\$62.50	SM72CD.....\$49.75	BM72.....\$35.00		PB40.....\$89.50
1973 ALL.....SM73.....\$79.50	SM73CD.....\$49.75			
1974 ALL.....SM74.....\$79.50				

Misc. Literature

1970 "Engineer Approved Accessories" pamphlet.
AL70.....\$11.00 ea.

Assembly Manuals

AM69B.....1969 All\$29.50 ea.
AM70.....1970 All\$29.50 ea.
AM72.....1972 All\$29.50 ea.

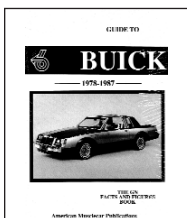

GN, T-Type and GNX

This book was the first to cover every Buick Regal Turbo Car from 1978-1987.
GNB1.....\$25.75 ea.

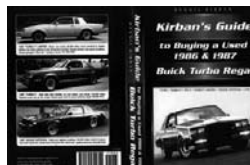

Dennis Kirban's Guide

To Buying a Used 1986 and 1987 Buick Turbo Regal, Grand National, GNX.
KG1.....\$20.50 ea.



Dennis Kirban's Guide

To 1986 & 1987 Buick Turbo Regal, Grand National, GNX.
KG2.....\$36.00 ea.

Hardware - Push-In Wire Clips (Group 17)



1/4" - 3/16" Hole size.
1/2" x 1/2".
MC3\$0.50 ea.
MC3B Box 100\$25.00 ea.



11/16" x 9/16" Head.
5/16" Hole size.
MC20\$0.50 ea.
MC20B Box 100.....\$25.00 ea.



1/2" Head diameter.
5/16" Hole size.
MC5\$0.50 ea.
MC5B Box 100\$25.00 ea.



1" x 7/8" Head.
5/16" - 3/8" Hole size.
MC21\$0.50 ea.
MC21B Box 50\$25.00 ea.



1/2" Head diameter.
1/4" Hole size.
MC12\$0.50 ea.
MC12B Box 100\$25.00 ea.



7/8" x 7/8" Head.
5/16" - 3/8" Hole size.
MC22\$0.50 ea.
MC22B Box 50\$25.00 ea.



5/8" x 5/8" Head.
5/16" Hole size.
MC13\$0.50 ea.
MC13B Box 50\$14.00 ea.



1" x 1 1/8" Head.
5/16" - 3/8" Hole size.
MC24\$0.50 ea.
MC24B Box 50\$12.50 ea.



3/4" Head diameter.
5/16" - 3/8" Hole size
MC16\$0.65 ea.
MC16B Box 100\$25.00 ea.



5/8" x 5/8" Head.
1/4" to 5/16" Hole size.
Tabs can be bent or cut to fit
smaller moldings.
MC54\$0.50 ea.
MC54B Box 25\$7.75 ea.



3/4" x 15/16" Head.
5/16" Hole size.
MC17\$0.50 ea.
MC17B Box 100\$25.00 ea.

Moulding Clips Threaded Type, (Nuts Included)

7/8"



10 - 24 x 3/4" stud.
MC63.....\$0.75 ea.
MC26B
Box 50\$18.75 ea.

1 1/8"



10 - 24 x 3/4" stud.
MC66.....\$0.75 ea.

1 3/4"



10 - 24 x 3/4" stud.
MC69.....\$1.00 ea.

2"



8 - 32 x 1" stud.
MC72.....\$0.50 ea.

1 3/4"



10 - 24 x 1/2" stud.
MC75.....\$2.75 ea.

1"

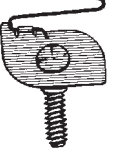

10 - 24 x 5/8" stud.
MC64.....\$0.75 ea.

1 3/4"



Adjustable.
10 -24 x 5/8" stud.
MC70.....\$1.25 ea.

2 1/2"



12 - 24 x 7/8" stud.
MC73.....\$1.00 ea.

1 5/16"



10 - 24 x 3/4" stud.
MC68.....\$0.75 ea.

1 7/8"



10 - 24 x 5/8" stud.
MC71.....\$0.75 ea.

Universal Break-Off Type

10 - 24 x 3/4" stud.
MC1\$1.00 ea.



Door Panel Fasteners



Head Dia.3/4"
Stem Length.....1/2"
Fits Hole Size.....1/4"
DPF1.....\$0.50 ea.



Head Dia.7/8"
Stem Length.....3/4"
Fits Hole Size.....1/4"
DPF2.....\$0.50 ea.



Head Dia.3/4"
Stem Length.....3/4"
Fits Hole Size.....1/4"
DPF3.....\$0.50 ea.



Head Dia.15/16"
Stem Length.....1 1/4"
Fits Hole Size.....1/4"
DPF4.....\$0.55 ea.



Head Dia.15/16"
Stem Length.....5/16"
Fits Hole Size....11/16"
DPF5.....\$0.50 ea.



Head Width.7/16"
DPF6.....\$1.00 ea.



Head Width.5/8"
DPF7.....\$1.00 ea.



Head Dia.1/2"
Stem Length.....3/4"
Fits Hole Size.....1/4"
DPF8.....\$0.25 ea.

Misc. Retainers



Head Dia.7/16"
Stem Length.....7/16"
Fits Hole Size.1/8"
WF2.....\$0.75 ea.



Head Dia.7/16"
Stem Length.5/8"
Fits Hole Size.1/8"
WF3.....\$1.00 ea.



Head Dia.9/16"
Stem Length.3/4"
Fits Hole Size.1/8"
WF4.....\$1.00 ea.

Push-In Clips

7/8"

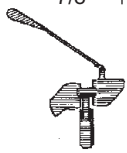

For 5/16" - 3/8" hole.
MC47\$0.75 ea.

1 1/4"



5/16" hole.
MC49\$0.75 ea.

1 1/4"

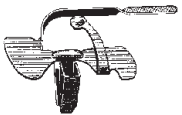

For 3/8" hole.
MC50\$0.75 ea.

1 3/4"

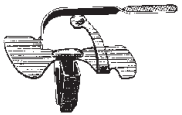

For 3/8" hole.
MC51\$2.25 ea.

Universal Wire Moulding Clips Push-in Type



5/16" - 1/2" Moulding.
3/8" Hole size.
MC29\$0.50 ea.
MC29B..Box 50..\$12.50 ea.

Nylon Clips

Push into oval holes in panels, then moulding snap over them.

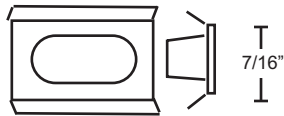

MC84\$2.25 ea.

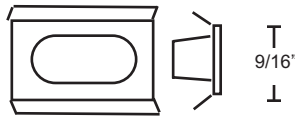

MC85\$2.25 ea.



MC86\$2.25 ea.



MC600\$1.00 ea.

Chrome Trim Screws



#6 Chrome Plated Phillips Oval Head

TS612.....	6x1/2"\$0.25
TS658.....	6x5/8"\$0.25
TS634.....	6x3/4"\$0.25
TS678.....	6x7/8"\$0.25
TS6100.....	6x1"\$0.50
TS6114.....	6x1 1/4"\$0.50

#8 Chrome Plated Phillips Oval Head

TS8386.....	8x3/8" w/ #6 Head.....	\$0.25
TS812.....	8x1/2".....	\$0.25
TS8126.....	8x1/2" w/ #6 Head.....	\$0.50
TS858.....	8x5/8".....	\$0.25
TS8586.....	8x5/8" w/ #6 Head.....	\$0.25
TS834.....	8x3/4".....	\$0.50
TS8346.....	8x3/4" w/ #6 Head.....	\$0.50
TS83410.....	8x3/4" w/ #10 Head.....	\$0.50
TS878.....	8x7/8".....	\$0.50
TS8786.....	8x7/8" w/ #6 Head.....	\$0.50
TS8100.....	8x1".....	\$0.50
TS81006.....	8x1" w/ #6 Head.....	\$0.50
TS8118.....	8x1 1/8".....	\$0.50
TS81186.....	8x1 1/8" w/ #6 Head.....	\$0.50
TS8114.....	8x1 1/4".....	\$0.50
TS81146.....	8x1 1/4" w/ #6 Head.....	\$0.50
TS8112.....	8x1 1/2".....	\$0.50
TS81126.....	8x1 1/2" w/ #6 Head.....	\$0.50
TS81346.....	8x1 3/4" w/ #6 Head.....	\$0.75

#10 Chrome Plated Phillips Oval Head

TS1012.....	10x1/2".....	\$0.50
TS10128.....	10x1/2" w/ #8 Head.....	\$0.50
TS1058.....	10x5/8".....	\$0.50
TS1034.....	10x3/4".....	\$0.50
TS1000.....	10x1".....	\$0.50
TS10008.....	10x1" w/ #8 Head.....	\$0.50
TS10114.....	10x1 1/4".....	\$0.50
TS101126.....	10x1 1/2" w/ #6 Head.....	\$0.50
TS10134.....	10x1 3/4" w/ #6 Head.....	\$0.750

Windshield and Backglass Moulding Clips



1969-1975
1969-1970:
 LeSabre and Wildcat
 two door models.
 Backglass. 22 per car;
1971-1972: All Electra, LeSabre and
 Wildcat four door hardtops.
 Backglass. As required;
1971-1972: All Electra. Backglass.
 As required;
1973-1975: All windshield. Backglass
 and 1/4" glass. As required.
 MC32.....\$0.75 ea.



1968-1971
 1968: All with soft
 roof trim.
 Windshield upper
 and side.
 Backglass. As required;
1969-1971: All windshield and
 backglass. As required.
 MC33.....\$0.75 ea.



1965-1968
 All windshield
 and Backglass.
 As required.
 MC34.....\$1.00 ea.



1966-1975
 All as required.
 Windshield and
 Backglass.
 (Emergency - screw-on type).
 MC37.....\$1.75 ea.



1963-1965 Windshield &
 back glass. 26 needed per
 car.
1963-1966
 MC91.....\$1.00 ea.



1968-1973 All windshield and
 Backglass (Emergency) As required.
 MC35.....\$1.00 ea.



1974-2015
 All as required.
 MC101.....\$1.00 ea.

Other Windshield - Backglass Clips (Use as required)



Windshield & backglass
 clips. Use as required.
 MC43.....\$0.75 ea.



Windshield & backglass
 clips. Use as required.
 MC44\$0.75 ea.



Windshield & backglass
 clips. Use as required.
 MC42.....\$0.75 ea.



Windshield & backglass
 clips. Use as required.
 MC39.....\$1.00 ea.

Window Rollers (see also window bearings on next page)



1957 thru 1972
 all as required
 WR576...\$3.25 ea.



1978 thru 1995 all as
 required. 5/16" wide.
 WR785.....\$6.50 ea.



1968 thru 1978 all as
 required. 7/16" wide.
 WR682.....\$6.50 ea.



1968-1975 as required.
 5/16" wide.
 WR685...\$16.00 ea.



1972 thru 1999 all as
 required. 11/64" id.
 WR727.....\$2.25 ea.



1979-2004 as req.
 With metal insert.
 WR790.....\$3.75 ea.

Hardware Section (Group 17)



Tubular Nuts (8.921)

For attaching monograms, emblems, etc. with studs. Measure your pin diameter and the size of the hole. Consider nylon tubular nuts. Although not original, they will not rust or chip paint.

Stud size 1/16" Hole size 9/64"

TN1.....Nylon\$0.50 ea.

TN1P.....Pack of 25\$7.75

Stud size 3/32" Hole size 1/8"

TN2.....Steel\$0.25 ea.

TN2P.....Pack of 25\$6.75

Stud size 1/8" Hole size 5/32"

TN3.....Steel\$0.25 ea.

TN3P.....Pack of 25\$6.75

Stud size 5/64" Hole size 5/32"

TN4.....Nylon\$0.50 ea.

TN4P.....Pack of 25\$7.75

Stud size 1/8" Hole size 11/64"

TN5.....Nylon\$0.50 ea.

TN5P.....Pack of 25\$9.75

Stud size 1/8" Hole size 3/16"

TN6.....Steel\$0.50 ea.

TN6P.....Pack of 25\$9.75

Stud size 1/8" Hole size 1/4"

TN7.....Steel\$0.50 ea.

TN7P.....Pack of 25\$8.75

Stud size 5/32" Hole size 7/32"

TN8.....Steel\$0.50 ea.

TN8P.....Pack of 25\$12.75

Stud size 5/32" Hole size 3/16"

TN9.....Nylon\$0.50 ea.

TN9P.....Pack of 25\$7.75

Stud size 3/16" Hole size 7/32"

TN10.....Steel\$0.50 ea.

TN10P.....Pack of 25\$8.75

Stud size 3/16" Hole size 13/64"

TN11.....Steel\$0.50 ea.

TN11P.....Pack of 25\$8.75

Stud size 1/4" Hole size 5/16"

TN12.....Steel\$0.50 ea.

TN12P.....Pack of 25\$9.75



Flat Nuts (8.921)

For attaching monograms, emblems, etc. with studs. Measure your stud diameter.

FN1.....1/16"\$0.25 ea.

FN1P.....Pack of 25\$4.75

FN2.....3/32"\$0.25 ea.

FN2P.....Pack of 25\$4.75

FN3.....1/8"\$0.25 ea.

FN3P.....Pack of 25\$4.75

FN4.....5/32"\$0.25 ea.

FN4P.....Pack of 25\$4.75

FN5.....3/16"\$0.25 ea.

FN5P.....Pack of 25\$4.75

FN6.....1/4"\$0.25 ea.

FN6P.....Pack of 25\$5.75

FN7.....5/16"\$0.25 ea.

FN7P.....Pack of 25\$5.75

Round Flat Nuts (8.921)



FN8.....1/8"\$0.25 ea.

FN8P.....Pack of 25\$5.75

FN9.....3/16"\$0.25 ea.

FN9P.....Pack of 25\$5.75

Cage Nuts /"U" Nuts

(8.155)



1935-1960 All as

required. Cage nut.

CN363.....\$3.25 ea.



For 5/16"-18 Screw.

Range - .025" - .060"

Center of hole to edge -

9/16"

UN1\$.50 ea.

UN1B.....Box of 50\$17.00 ea.



For 3/8"-16 Screw.

Range - .050" - .200"

Center of hole to edge -

3/4"

UN2\$.75 ea.

UN2B.....Box of 25\$15.00 ea.

Thread Cutting Nuts



Sold in packs of 25 pieces (8.921)

For 1/8" stud. 5/16" Hex.

7/16" washer OD. Zinc plated.

TCN18516\$4.25 pack

For 1/8" stud. 1/4" Hex. Zinc plated.

TCN1814\$4.25 pack

For 5/16" stud. 1/2" Hex.

7/8" washer OD. Zinc plated.

TCN51612\$4.25 pack

For 5/32" stud. 11/32" Hex.

9/16" washer OD. Zinc plated.

TCN53238\$4.50 pack

For 3/16" stud. 3/8" Hex.

1/2" washer OD. Zinc plated.

TCN31638\$4.25 pack

For 1/4" stud. 7/16" Hex.

9/16" washer OD. Zinc plated.

TCN14716\$4.25 pack

Window Bearings



1968-1974 as required. low

profile. 1 7/32" dia.

WB684A\$3.75



1968-1974 as required.

1" dia.

WB684B\$3.75



1968-1974 as required.

1" dia. high cap.

WB684C\$3.75

Buick License Plates

Laser Cut License Plates

These beautiful license plates are made of durable high impact acrylic and are approximately 3/16" thick. Hand inlaid design.

1913 Buick Logo



Black acrylic with bright red square. The "Buick" is shiny mirror like. LP1\$25.75

Buick Tri-Shield - Gold



Black acrylic with gold mirror lettering. Tri-Shield is red, white and blue inlay. LP9\$25.75

Buick Tri-Shield - Silver



Black acrylic with silver mirror lettering. Tri-Shield is red, white and blue inlay. LP8\$25.75

T-Type Turbo 6



Black acrylic with bright yellow/red laser cut and inlaid insignia. LP7\$25.75

Silk Screened License Plates

Heavy gauge embossed aluminum plate.

Buick Tri-Shield



Black with white shield and white "BUICK" lettering. LP2\$9.75

Buick Gold Hawk



Black with gold BUICK Hawk. Sharp! LP3\$9.75

GS by Buick



Black with red "GS" and white "Fast with Class" LP4\$9.75

Grand National



Black plate, red and yellow "6" with gold lettering. LP6\$9.75

Buick License Plates - Frames and Accessories

License Plate Frame Solid Brass



These heavy, **solid brass** frames have "BUICK" stamped in the center flanked by the buick tri-shield. Gold & Chrome (pictured) available.

- Gold - LP13\$25.75
- Chrome - LP12\$25.75

License Plate Grand National



Bad to the bone.

- LP19\$7.25

License Plate Cover Bubble Cover

Protect your License plate with this clear see-thru bubble cover.

- LP14\$15.50

"GO BUICK"



These were found recently in the back room of an old Buick Dealership in Bayonne, NJ. Estimates are that these were from the 1970's.

- LP18\$6.25

Stainless Steel License Plates



Shiny **Stainless Steel** license plate with clear lettering. Tri-Shield is red, white and blue.

- LP10 (Clear Letters)\$25.75
- LP11 (GOLD Letters)\$25.75
- LP20 (BLACK Letters)\$25.75

Index

A

Air Cleaner Identification 9

Air Conditioning 49

Compressor 49

Antenna 49

Assembly 49

Lead 49

Mast and Tube 49

Retaining Nut 49

B

Body Molding 60

Body Mounting 47

Body to Frame Mounting Pad 48

Brakes 33

Brake Booster Hose Pinch Clamp 33

Brake Booster Vacuum Check Valve 33

Cable 36

Cylinder 34

Disc Brake Caliper Repair Kit 34

Hose 35

Master Cylinder 34

Master Cylinder Rebuilding Kit 34

Overhaul Kit 33

Pedal 36

Pedal Pad 36

Power Brake Rebuilding Service 33

Shoes and Disc Pad Set 35

Spring Kit 35

Stop Light Switch 36

Wheel Cylinder Repair Kit 34

Bumper 43

Filler 44

Insulators and Grommets PB 44

C

Carburetion 28

Carb. Mounting Gasket 29

Carburetor Kit 28

Carter Baffle Plate 28

Carter Carburetor 28

Choke Stove Pipe Replacement Kit 28

Rebuilding and Restoration Service 28

Rochester Carburetor 28

Carpet 69

By the Yard 69

Custom Form Molded Carpet Sets 69

Door Panel Bottom 69

Jute Padding 69

Cooling 12

Fan Belt 13

Fan Shroud 13

Hose Clamp 12

Radiator Cap 12

Radiator Hose 12

Temperature Sending Unit 13

Thermostat 12

Water Manifold Gasket Kit 13

Water Pump 13

Water Pump Mounting Gasket 13

Wire Hose Clamp 13

D

Decals 10

Air Cleaner 10

Air Conditioning 11

Emission 11

Exterior 11

Interior 11

Valve Cover 10

Dome Lens 57

Door and Roof Rail Weatherstripping 51

Door Weatherstrip Set 51

Roof Rail Weatherstrip Sets 51

Weatherstrip Kit 51

Window Channel Kit 51

Door Sill 57

E

Electrical 18

Alternator Brush Set 23

Alternator Contact Rubber Boot 23

Alternators 23

Back-up Lamp Part PB 24

Battery Bolt 17

Battery Cable 16

Battery Clamp 17

Battery Part 16

Bulbs 26

Distributor Knock Sensor 19

Distributor Rebuilding Service 23

Headlamp Motor Repair 24

Headlamp Switch PB 26

Headlight Bezel Nut PB 26

Headlight Bulb PB 26

Headlight Dimmer Switch PB 26

Headlight Support Pad PB 26

Horn Blowing Contact Spring 23

Horn Relay 23

Horns 23

Ignition Coil 19

Ignition Lock Cylinder with Keys 20

Ignition Wire Set 19

Key Blank 20

Key Cap 20

License Lamp Gasket PB 24

Nylon Wire Loom 16

Signal Flasher 19

Spark Plug 19

Spark Plug Wire 22

Spark Plug Wire Part 19

Starter Brush Set 18

Starter Drive 18

Starter ID Tag 18

Starter Rebuilding Service 18

Starter Solenoid 18

Starter Solenoid Repair Kits 18

Tail Lamp Bezel PB 24

Tail Lamp Gasket PB 24

Tune-up Kit 19

Tune-up Part 19

Turn Signal Lever 19

Universal Coil Bracket 19

Index

Vacuum Advances 23
Voltage Regulator 18
Wire and Cable Retainer 18
Wiring Harness Tape 16, 19
Engine Enamel 8
Engine Compartment & Chassis Paint 8

Engine Parts 2
Breather Tube 6
Connecting Rod 2

Bearing 2
Crankshaft Main Bearing Set 2
Flywheel 4
Freeze Plug Kit 4
Gasket 7

Cylinder Head 7
Full Engine Overhaul Gasket Set 7

Push Rod 7

Valve Cover 7
Harmonic Balancer 3

Bolt 3
Hydraulic Valve Lifters 7
Motor Mount 2
Oil Slinger 5
Push Rods 7
Rocker Arm 5

Assemblies 5
Rebuilding 5

Retainer 5

Set 5

Shaft 5
Timing Chain Cover 2
Timing Chain Set 2
Timing Cover Gasket Set 2
Timing Cover Seal 2
Valve 4

Cover 6

Exhaust 4

Guides 4

Intake 4

Spring 4

Spring Retainer 4
Valve Rocker Cover 6

Exhaust 30
Manifold French Lock 30
Manifold Gaskets 30
Part 30

Exterior Door Parts 52
Door Handles and Gaskets 53

F

Floor Mat 69
Front Fender 46
Monogram 46

Moulding Clip 46
Patch Panel 46
Front Vent 50
Cowl Seals and Clips 50
Weatherstrip 50

Fuel 29
Air Cleaner Heat Pipe 30
Air Cleaner Part 30
Air Filter Element 30
Breather Tube 30
Crankcase Ventilation Filter 30
Filter 29
Fuel Pump 31
Fuel Pump Block-Off Plate 31
Fuel Pump Hardware Kit 31
Fuel Pump Rebuilding Kit 31
Gas Tank Cap 31
Gas Tank Part 31
Intake Manifold Gasket 30
Intake Manifold Plug 29
Mass Air Flow Sensor 29
Pinch Clamp 29
Ported Vacuum Switch 29
Prom Calibrator 29
Rod Clip 29

H

Hardware 74
Backglass Clip 77
Chrome Trim Screw 76
Door Panel Fastener PB 75
Moulding Clip PB 75
Retainer PB 75
Universal Break-Off Type PB 75
Window Roller 77

Headliners 68
Package Shelf Material 68
Rear Sail Panel 68
Sound Deadening Material 68
Sunvisor Recovering Service 68

Heating 49
Control Valve 49
Core 49

Hood 45
Emblem 45
Insulation 45
Opening Rod 45
Release Cable 45
Seal 45
Spray Adhesive for Application of Hood Insulation 45

I

Interior Door Parts 54
Air Duct Hose 55
Door Hinge Pins and Bushings 55
Door Sill Plate 55
Drain Hole Seal 55
Glove Box 56
Handle Removal Tool 54
Inside Door Handles 54
Lock Buttons and Ferrules 54
Power Door Locks and Bezels 54

Index

Power Vent Window Gears 54
Sunshade Rest Grommet 56
Sunshade Sleeve 56
Vent Crank Handles 54
Visor Support 56
Window Crank Handles 54
Window Roller 55

L

Literature 73

CD-ROM 73
Chassis and Body Parts Book 73
Shop Manual 73

O

Oiling 14

Adjustable Oil Pressure Regulator 15
Air Cleaner to Rocker Cover Vent Tube 15
Crankcase Vent Hose 15
Distributor Gear Oiler 14
Oil Filler/Breather Cap 14
Oil Filter 14
Oil Gasket 15
Oil Pan 14
Oil Pick-up Tube and Screen 14
Oil Pump 14
Oil Pump Kit 14
Oil Pump Thrust Plate Repair Kit 15
PCV Valve 15
Rocker Cover Plug 15

P

Push-In Wire Clip 74

Nylon Clip 76
Universal Wire Moulding Clip 76

R

Rear 1/4 Panel 59

Ornament 59
Ornament Clip 59

Rear Axle 39

Backing Plate Gasket 39
Control Arm Bushing 39
Cover Gasket 39
Oil Seal 39
Parts 39
Pinion Seal 39
Posi-Traction Additive 39
Posi-Traction Tag 39
Wheel Bearing 39

Rear Glass 57

Lock Pillar Seal 57
Window Seal 57

Rocker Panel 46

Roof 59

Landau Top 59
Plastic Side Moulding Clip 59
Roof Panel Emblem 59
Side Molding Clip Kit 59
Sunroof Weatherstripping 59
Vinyl Roof 59

S

Seat Belt 67

Sheet Metal 58

Door Panel Retainer 58
Floorpan 58
Rocker Panel 58

Shock Absorber 43

Spring 43

Coil Spring Insulator 43

Steering 40

Box Kit 40
Centerlink Rebuilding Service 41
Control Arm 41
Coupler 40
Front Wheel Bearings and Seals 42
Grease Fitting 41
Idler Arm 41
Parts 41
Pitman Shaft Seal Kit 40
Pump Kit 40
Pump Pulley 40
Pump Reservoir Cap 40
Stabilizer Bar to Frame Bushings 42
Stabilizer Kit 42
Tie Rod 42
Tie Rod Adjusting Sleeve 42
Wheel Stud 42

Suspension 40

Front End Rebuilding Kit 40

T

Transmission 32

Gaskets and Oil Seals 32
Speedometer Cable 32
Speedometer Cable Lubricant 32
Transmission Kit 32
Transmission Mount 32
Transmission Mount Rebuilding Service 32

Trunk 60

Emblem 60
Support 60

Trunk Lining 69

U

Upholstery Set

Full Vinyl Set PB 61

W

Wheels 37

Brake Drum 38
Caps and Parts 37
Constant Velocity Repair Kit 38
Driveshaft Part 38
Nut 37
Universal Joint 38

Windshield 50

Washer Part 50
Washer Pump Repair Kit 50
Wiper Hose 50

Wood Kit 66

Console Kit 66
Door Panel Kit 66
Full Interior Kit 66



www.oldbuickparts.com

NEVER CHANGE POINTS AGAIN!

UPGRADE TO AN ELECTRONIC IGNITION. FITS ENTIRELY INSIDE THE DISTRIBUTOR.
 INSTALLS AS QUICKLY AS CHANGING A SET OF POINTS. NO BLACK BOXES,
 COMPLICATED WIRING OR SPECIAL BRACKETS. ONLY TWO WIRES TO CONNECT.

IGNITOR ELECTRONIC IGNITION KITS

NO.

PRICE

8 CYLINDER

1937-1953 ALL Straight 8, 6 volt, negative ground.....	PI1183N6	\$82.25
1937-1953 ALL Straight 8, 12 volt, negative ground (original distributor)	PI1183	\$74.75
1953-1956 ALL V-8 Mechanical advance under baseplate	<i>New Design - No Magnet Ring</i> PI1185LSC	\$69.50
1957-1974 ALL V-8 Except 215, 300, 340 Engines	<i>New Design - No Magnet Ring</i> PI1181LSC	\$69.50
1957-1974 ALL V-8	PI1181	\$67.50
1957-1974 ALL V-8 (IGNITOR II)	PI91181	NEW \$95.25

6 CYLINDER

1968-1974 All	PI1162A	\$67.50
1962-1967 V-6 Engine.....	PI1164	\$67.50
1962-1967 V-6 Engine (Odd Fire)	PI1165	\$67.50

HIGH PERFORMANCE COILS (40,000 VOLT WITH STOCK APPEARANCE)



1937-1953 ALL Straight 8, 6 volt, negative ground (BLACK).....	PC45011	\$35.75
1937-1953 ALL Straight 8, 6 volt, negative ground (CHROME)	PC45001	\$44.00
1953-1974 ALL (BLACK)	PC40011	\$29.50
1953-1974 ALL (CHROME) 12 v.....	PC40001	\$37.50
1953-1974 ALL (FOR IGNITOR II APPLICATIONS ONLY)(CHROME) 12 v.....	PC45001	NEW \$44.00
1953-1974 ALL (FOR IGNITOR II APPLICATIONS ONLY)(BLACK) 12 v.	PC45011	NEW \$35.75
Coil Bracket	CB350	\$6.75
Coil Bracket (CHROME).....	CB350C	\$9.50

HIGH PERFORMANCE SPARK PLUG WIRES

Low 500 ohm/ft. resistance with spiral wound alloy to suppress electromagnetic radiation plus redundant current paths.

V-8 7.0MM STOCK-LOOK CUSTOM SET

1960-1967 Special, Skylark, GS (Ex 1967 GS 400)	PW708103	\$39.50
1953-1960 All	PW708103	\$39.50
1967-1966 Lesabre, Wildcat, Invicta, Electra, Riviera All 364,401,425 Engines.....	PW708105	\$39.50
1967 GS -400.....	PW708102	\$39.50
1968-1974 All 350, 400, 430, 455 w/o HEI	PW708102	\$39.50

6 CYLINDER 7.0MM STOCK-LOOK CUSTOM SET

1968-1974 ALL.....	PW706101	\$39.50
--------------------	----------	---------

Telephone Number: 908-369-3666 Fax: 908-369-7595

Catalog Order Form

YEAR _____ CARB. _____

NAME _____ TRANS. _____
 SUPER, ROADMASTER

SERIES _____ POWER BRAKES _____
 40,50,70,4800,ETC.

BODY STYLE _____ POWER STEERING _____

ENGINE, CU. IN. _____ AIR CONDITIONING _____

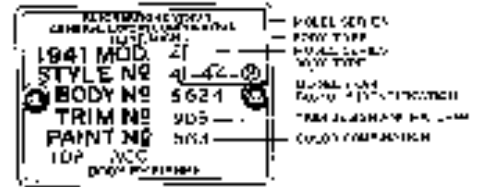

CREDIT CARD BILLING ADDRESS

COMPANY _____
NAME _____
ADDRESS _____
CITY _____ STATE _____ ZIP _____
DAYTIME TELEPHONE _____

SHIPPING ADDRESS (if different)

COMPANY _____
NAME _____
ADDRESS _____
CITY _____ STATE _____ ZIP _____
EVENING TELEPHONE _____

NOTE: ALWAYS GIVE STREET ADDRESS: UPS AND TRUCK LINES CANNOT DELIVER TO POST OFFICE BOXES.

QTY	GROUP NUMBER	PART NUMBER	DESCRIPTION	PRICE EACH	TOTAL PRICE OF ITEMS

Credit Card Information

Visa Mastercard Discover

IMPORTANT: COPY ACCOUNT NUMBER FROM YOUR CREDIT CARD

□□□□ □□□□ □□□□ □□□□

EXPIRATION DATE MONTH □□ YEAR □□ CVV2 □□□

3 Digits on Back

SIGNATURE _____

NOTE: ADDRESS ABOVE MUST BE EXACTLY AS IT APPEARS ON YOUR STATEMENT

SUB TOTAL	
US Shipping Add 10% (\$9.50 Min.)	
US Residential Delivery (\$1.50/\$2.50)*	
NJ Addresses Add 7% Sales Tax	
TOTAL AMOUNT	

*Note: UPS charges extra for residential type delivery (\$1.10) as well as an extended rural area delivery fee (\$1.50). These charges are not well defined by UPS and may affect your order total. We suggest you include these charges if you are unsure. We will gladly refund your money if not required.



Membership/Renewal Application

Riviera Owners Association, P.O. Box 261218, Denver, CO 80226-9218
 phone: 303-233-2987 • fax: 303-984-0909 • email: office@rivowners.org • website: www.rivowners.org

A non-profit membership corporation dedicated to the 1963-1999 Riviera by Buick

New Member Renewal: ROA # _____ Prior ROA Member # _____ (if known)

Name _____ Spouse _____

Address _____

City _____ State _____ Zip _____

Country _____ Phone (____) _____ email: _____

How did you learn about ROA? ROA website Other website BCA Magazine ad Referral Other

Rivieras Currently Owned (ownership is not required)								
Year	Model (GS, etc.)	Mileage	Color (in & out)	Original	Restored	Under Restoration	Modified	Custom

Benefits of Membership

- Membership card, decal and club cards.
- Six bimonthly issues of *the Riview*, our 36-page color magazine with Technical Tips, Members Showcases Classifieds and more.
- Free 45-word advertisement per member, per issue.
- Access to the "Members Only" section of our website.
- Access to past issues of *the Riview*, posted on our website.
- Access to technical advice and our extensive library.
- Participation in international and local events.
- International Air Mail included.

MULTI-YEAR RENEWALS	
U.S.:	1 year = \$35.00
	2 years = \$65.00
	3 years = \$95.00
Foreign: (Air Mail)	1 year = \$40.00
	2 years = \$75.00
	3 years = \$110.00

Methods of Payment

1. Online payments are accepted by credit card or PayPal on our website at www.rivowners.org.
2. Checks and Money Orders made out to "Riviera Owners Association" or "ROA." Applicants outside the USA must use checks drawn on a US bank and made payable in US dollars.
3. Complete the information below to pay by credit card.

We accept: Amount enclosed \$ _____

Acct. # _____ - _____ - _____ Exp. Date (MM/YY) _____

Print Name on Card _____ Signature _____

Mail to ROA, P.O. Box 261218, Denver, CO 80226-9218

Ordering Instructions

ORDER BY TELEPHONE, FAX or ONLINE

Monday through Friday, 8:30 am to 5:00 pm.
Saturday 9.00 am to Noon. Please call in advance.

Telephone: 908-369-3666

Fax: 908-369-7595.

ORDER BY MAIL. Please use Catalog Item Order Form, giving complete information requested. Order by Part numbers. If you do not have enough space use back of the form or on a plain piece of paper.

Shipping and Handling Charges

Shipping, Handling and Insurance charges are shown on the order form. Add 10% to orders under \$100.00 but not less than our \$9.90 minimum shipping charge. We pay shipping on orders over \$750.00 of in-stock, non special order items by within the 48 states (Not included are custom made items, rebuilt or special orders). Large items (fenders, hood, etc.) are shipped freight collect by common carrier. Foreign Customers please add 20% to order for shipping and handling. Additional shipping charges will apply to large or heavy items. (All Air Shipments, Blue Label, etc. are additional).

Means of Payment



Personal Checks:

We will gladly accept your personal check and will not hold it for bank clearance if you provide your drivers license number on the check and we can obtain approval through a nationally recognized check clearing service. Should such approval not be obtained, we reserve the right to hold personal checks pending bank clearance.

Foreign: All orders are payable in U.S. funds only.

Damages in Shipment

Damage in transit is the responsibility of the delivering carrier. Retain all packing materials and immediately contact CARS, Inc. to file your claim. Do not return damaged items to us as further shipping will result in the loss of claim settlement.

Guarantee - Returns

Your satisfaction is very important to us. If you are not satisfied with an item please phone and tell us why. We will accept any returned item within 30 days of the sale (call first to obtain RMA) provided it is in good unused condition and is returned prepaid with a copy of our receipt. Parts returned through no fault of CARS, Inc. will be subject to a restocking charge. We will then (at our option) replace the item or refund the original cost. Not included in this policy are custom made items such as yard goods, carpets etc., electrical items, and some used parts. Labor charges are not refundable. Returns will effect discount and free shipping programs. Absolutely no claims/returns can be made after 30 days

Items returned without RMA approval # clearly marked on the outside of the box may result in loss of any return credit whatsoever.

Back Orders

In the event an item is not in stock at the time of the order, we will back order until the item comes in or for 30 days at which time you may request a refund.

Subject to Change

All prices, part numbers, specifications, policies and terms are subject to change without notice. All parts subject to prior sale. Always double-check when ordering. Not responsible for errors in print.

Large Order Discount

We will extend a discount of 10% on orders of new parts totalling over \$1000 paid for by cash, personal check or US postal money order. Excluded are custom made items and all services. Friends and club members should find this advantageous by combining their orders to meet the quantity discount. All items, however, will be shipped to one address. Actual shipping charges will apply.

DEALER INQUIRIES WELCOME

CARS, Inc.

205 Pearl St.

Neshanic Station, NJ 08853

Main: (908) 369-3666

Fax: (908) 369-7595

Website: www.oldbuickparts.com





CARS, Inc.

205 Pearl St.

Neshanic Station, NJ 08853

(908) 369-3666 Phone

(908) 369-7595 Fax



www.oldbuickparts.com

